

# Abmessungen CS-MZ16ZKE

<Top View>

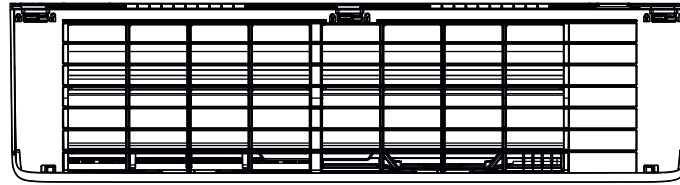

<Side View>

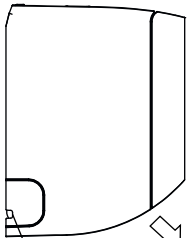
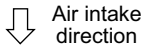

Left piping hole

Air outlet direction

<Front View>

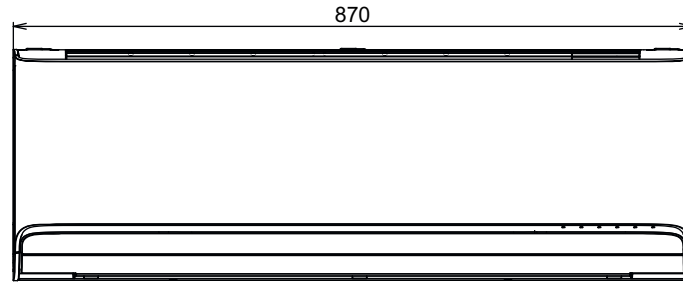

<Side View>

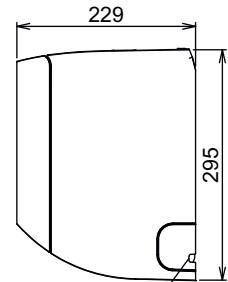

Right piping hole

<Bottom View>

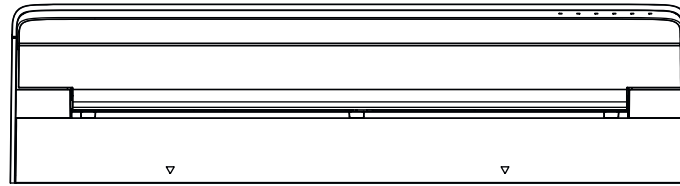

<Remote Control>

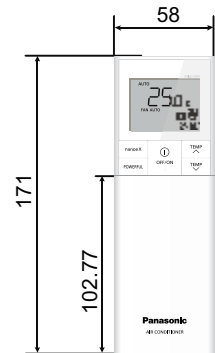

<Rear View>

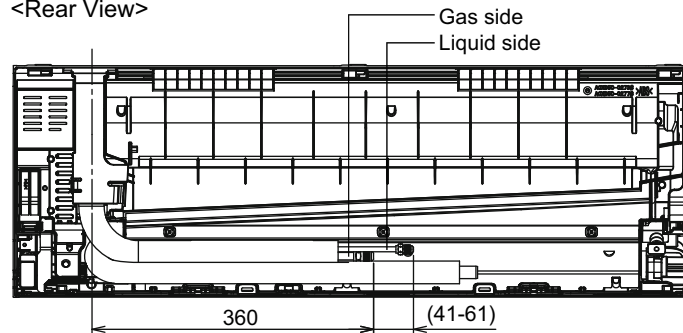

<Remote Control Holder>

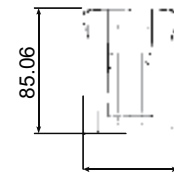

Relative position between the indoor unit and the installation plate <Front View>

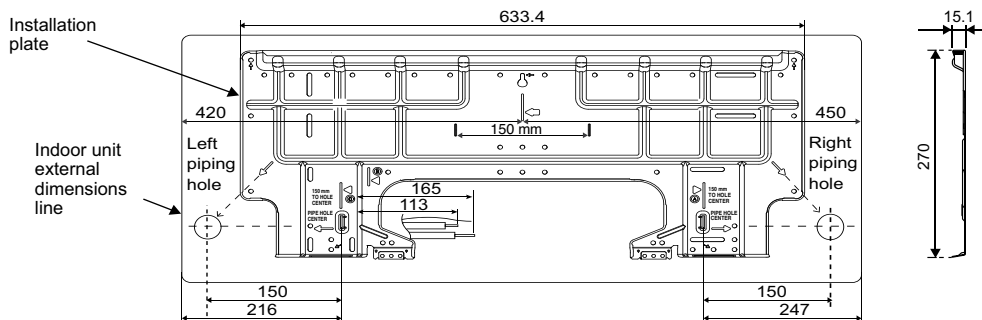

Unit: mm