

KAISAI

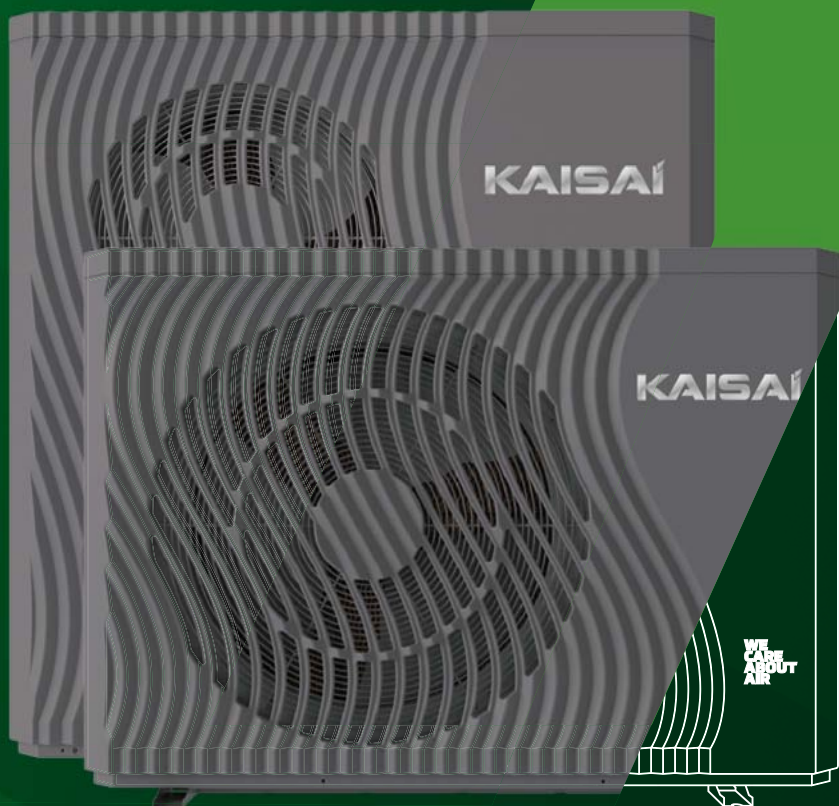

Installation & service manual

EN

HEAT PUMP AIR TO WATER 290
KHY-12PY3 | KHY-15PY3

KAISAI

HEAT PUMP AIR TO WATER

KHY-12PY3

KHY-15PY3

Installation and service manual

Thank you for choosing our product.

To ensure proper operation, please read and keep the instruction manual for future reference.

Table of Contents

| | |
|--|-----------|
| 1. Introduction | 6 |
| 1.1. Features of the device | 6 |
| 1.2. Functions | 7 |
| 2. Precautions | 8 |
| 2.1. Safety Instructions | 8 |
| 2.2. Important Information Regarding Refrigerant | 11 |
| 2.3. Maintenance | 12 |
| 2.4. Inspection | 14 |
| 2.5. Moving | 14 |
| 3. Technical information | 16 |
| 3.1. Accessories | 17 |
| 3.2. Dimensions of units | 17 |
| 3.3. Basic parameters | 19 |
| 3.4. Performance tables | 20 |
| 3.5. Schematic diagram of the heat pump's main board | 24 |
| 3.6. Schematic diagram of the installation layout | 25 |
| 4. Unit inspection | 27 |
| 4.1. Before installation | 28 |
| 4.2. Installation location | 32 |
| 4.3. Hydraulic connections | 36 |
| 4.4. Electrical connection | 39 |
| 4.5. Preparing the system for initial startup | 48 |
| 5. Controller manual | 48 |
| 5.1. Description of the display interface | 48 |
| 5.2. Mode selection interface | 51 |
| 5.3. Function Settings Interface | 52 |
| 5.4. Customer function interface | 53 |
| 5.5. The time function settings interface | 54 |
| 5.6. Circulation of domestic hot water | 55 |
| 5.7. Configuration of time functions | 55 |
| 5.8. SG Ready | 56 |
| 5.9. Multi-zone control | 64 |
| 5.10. Mute mode | 72 |
| 5.11. Curve | 72 |
| 5.12. Failure/Faults | 73 |

| | |
|---|------------|
| 6. Parameters | 73 |
| 6.1. System | 73 |
| 6.2. Protect | 77 |
| 6.3. Fan | 79 |
| 6.4. Defrost | 80 |
| 6.5. EEV | 84 |
| 6.6. Temp | 86 |
| 6.7. Pump | 89 |
| 6.8. Compressor | 89 |
| 6.9. Disinfection | 90 |
| 6.10. Zone | 91 |
| 6.11. SG Ready | 93 |
| 7. The logic of device operation | 94 |
| 7.1. The logic of switching between hot water mode and heating/cooling mode | 94 |
| 7.2. Compressor control | 94 |
| 7.3. Fan control | 95 |
| 7.4. Main circulation pump control | 96 |
| 7.5. The main circulation pump protection mode | 96 |
| 7.6. Manual control of the circulation pump output function | 97 |
| 7.7. Circulating pump for domestic hot water | 97 |
| 7.8. Electric Heater Control | 98 |
| 7.9. Manual activation/deactivation of the heater | 103 |
| 7.10. Disinfection Function | 103 |
| 7.11. Defrost tray heater control | 104 |
| 7.12. Defrost Function Control | 104 |
| 8. Maintenance | 107 |
| 8.1. Antifreeze Protection | 107 |
| 8.2. Troubleshooting | 109 |
| 8.3. Errors on the control board | 110 |
| 8.4. Errors of the fan | 115 |
| 8.5. Communication errors | 118 |
| 8.6. Sensors faults | 120 |
| 8.7. System faults | 123 |
| 8.8. Multiple-zone control malfunctions | 128 |
| 9. Components List | 129 |
| 9.1. Assembly Drawing | 129 |

1. Introduction

To ensure customers high quality and reliability of the products, the heat pump is manufactured according to strict design and production standards. This manual contains all necessary information regarding installation, assembly, disassembly, and maintenance. Please carefully read this manual before opening or performing maintenance on the device.

The manufacturer of this product is not liable if anyone gets injured or the device gets damaged due to improper installation, assembly, or maintenance not in accordance with this manual.

The device must be installed by qualified personnel. Warranty coverage for the device requires installation in accordance with the DTR guidelines and activation by an Authorized Service Partner.

To maintain the warranty, it is essential to always follow the provisions outlined in the instructions below.

- The device may only be opened or repaired by a qualified installer or an authorized dealer.
- Maintenance and servicing should be carried out according to the recommended schedule and frequency as provided in this manual.
- Only use original replacement parts.

Failure to follow these guidelines will void the warranty.

An inverter air-to-water heat pump is a type of high-efficiency, energy-efficient, and environmentally friendly device primarily used for heating homes. It can work with various heat emitters such as fan coil units, radiators, or underfloor heating systems. The heat pump is designed to provide both space heating and domestic hot water. A single outdoor unit of the monoblock heat pump can also collaborate with multiple indoor units simultaneously when connected to an external controller.

The air-to-water heat pump is also designed to work in conjunction with a domestic hot water heater for sanitary purposes.

1.1. Features of the device

- Plate heat exchanger: An efficient SWEP heat exchanger with compact dimensions and high efficiency is used.
- The device is delivered ready for operation and is filled with the R290 refrigerant.

- A new generation of environmentally friendly refrigerant R290 has been used, which is harmless to the ozone layer, and the Global Warming Potential (GWP) value for this refrigerant is 3.
- Heating in low outdoor temperatures. The optimally designed unit is capable of operating in heating mode even when the ambient temperature drops to -25°C .
- The KHY series heat pumps are factory-equipped with a communication module (DTU). This module is used to read the device's operating parameters, which the factory utilizes to enhance its product and increase customer satisfaction, as well as achieve maximum device efficiency in specific climates. The module does not record any sensitive data, such as detailed locations. Data collected by the module is stored by an external entity. Klima-Therm does not collect any data obtained by the DTU module. Klima-Therm also does not provide any remote control application for the device through the DTU module and is not responsible for creating accounts for customers in applications provided by external entities, their operation, or data collection. Users of applications handling the DTU module use them at their own risk, and Klima-Therm disclaims any responsibility for such actions.
- Klima-Therm does not offer any technical support for external applications provided by third-party suppliers that handle the DTU module.



The refrigerant R290 is flammable and explosive. It is prohibited to install it in an environment where active or potential ignition sources are present.

1.2. Functions

Heat pumps from the KHY series offer the following functions:

- **Advanced control**
Microcomputer-based controller allows users to view and adjust the heat pump's operational parameters. The centralized system enables the control of two heating circuits using the control panel. By using an additional external controller, it's possible to connect multiple units in a cascade configuration.
- **Modern design**
The heat pump has been carefully designed with attention to aesthetic appearance, ergonomics, and user-friendly operation.
- **Flexible Installation**
Thanks to its ergonomic design with a compact casing, the heat pump is easy to install outdoors.
- **Quiet Operation**
The heat pump unit utilizes a specially designed fan to minimize noise emissions.
- **High heat exchange coefficient.**
The heat pump utilizes a specially designed heat exchanger to enhance the overall efficiency of the unit.
- **The heat pump operates within a wide range of conditions.**

The heat pump is designed to operate in various working conditions, including low outdoor temperatures, for both heating and domestic hot water purposes.

2. Precautions



WARNING

Service information is intended solely for experienced technicians and is not meant for use by the general public. Products powered by electricity should only be serviced or repaired by experienced professional technicians. Any attempt to service or repair products described in this service information by individuals other than qualified technicians may result in serious injury or even death.



CAUTION



Refrigerant R290

The device contains the refrigerant R290. This product may only be installed and serviced by qualified personnel. Before installation, maintenance, and servicing, it is essential to familiarise with national regulations and safety instructions regarding working with refrigerants.





2.1. Safety Instructions

To ensure the safety of users, maintenance personnel, and installers, as well as to prevent any injuries or damage to the device or other property, and to properly operate the heat pump, please carefully read this instruction and understand the following information. It is prohibited to use the device for purposes other than intended.

Description of the labeling



| Labeling | Meaning |
|--|--|
|  WARNING | Incorrect actions may lead to death or serious injuries. |
|  CAUTION | Incorrect operation can result in injury to people or property damage. |



Opis ikon



| Labeling | Meaning |
|---|---|
|  | Prohibition. The icon indicates prohibited actions. |
|  | Mandatory actions necessary to perform. Follow the description accordingly. |
|  | CAUTION (including WARNING). Pay attention to what is indicated. |
|  | Fire Hazard / Flammable Materials |
|  | No Open Flame Allowed |





WARNING





| Operation | Meaning |
|---|--|
|  Prohibition | Do not insert fingers or any other objects into the fan and evaporator of the device, as doing so may cause damage. |
|  Turn off the power | In case of unusual operation or odors, disconnect the power to stop the device. Continuing its operation may lead to electrical short circuit or fire. |

| Moving and Repairs | Meaning |
|---|--|
|  Moving | In case the heat pump needs to be reinstalled or restarted, it should be advised to be performed by qualified individuals. Improper installation can lead to water leakage, electric shock, injuries, or fire. |
|  Order repair | Do not attempt to repair the device on your own, as it may result in electric shock or fire. |
|  Prohibition | When the heat pump requires repair, it should be entrusted to qualified individuals. Improper handling or repair of the device can lead to water leakage, electric shock, injuries, or fire. |

| | |
|---|---|
|  | Do not use any thawing or cleaning agents other than those recommended by the manufacturer. |
|  | The device should be stored indoors and installed in an environment without a constant or potential source of ignition (for example: open flame, operating gas appliance or electric heater, electrical spark, or hot objects). |

CAUTION

| Installation | Meaning |
|--|---|
|  Installation location | The device MUST NOT be installed near flammable gas. In the event of a gas leak, a fire may occur. |
|  Mounting the Device | It is important to ensure that the substructure of the heat pump is sufficiently sturdy to prevent the device from tipping over or falling. |
|  Electrical safeguards | Ensure that the device is equipped with an automatic switch-off; the absence of a switch-off mechanism can lead to electric shock or fire. |

| Maintenance | Meaning |
|--|--|
|  Checking the foundation structure | Regularly check the substructure on which the heat pump is installed (once a month) to prevent tipping, damage to the device, and personal injuries. |
|  Power off | Power off the device during cleaning or maintenance. |
|  Electrical safeguards | The use of copper or steel inserts as fuses is prohibited. Proper electrical safeguards must be selected by a qualified electrician. |
|  Prohibition | Spraying flammable gas on the heat pump is prohibited, as it may cause a fire. |

2.2. Important Information Regarding Refrigerant

- The refrigerant R290, also known as propane, is an organic chemical compound belonging to the group of hydrocarbons called alkanes. It is a pure hydrocarbon composed of two carbon atoms and six hydrogen atoms (C₃H₈). R290 is characterized by low molecular weight and excellent thermodynamic properties, making it suitable for use as a refrigerant in various cooling systems, including heat pumps.
- A key feature of R290 is its low Global Warming Potential (GWP) and zero Ozone Depletion Potential (ODP), which means that it has minimal impact on the greenhouse effect and the ozone layer. Thanks to these properties, it is considered a more environmentally friendly choice than some other refrigerants that can contribute to climate change and ozone depletion.
- In heat pumps, R290 is used as a refrigerant that plays a crucial role in the heat transfer process. In the refrigeration cycle of a heat pump, R290 undergoes phase changes (condensation and evaporation) to absorb heat from the surroundings and transfer it to the interior of a space. Its low boiling temperature and good thermodynamic properties allow for efficient operation of the device while maintaining high energy efficiency.
- However, it is important to remember that R290 is also flammable and requires appropriate precautions during installation, operation, and maintenance of systems containing this refrigerant. Therefore, it is important that individuals working with R290-based heat pumps have the necessary qualifications and technical knowledge to work safely with this refrigerant.

Information Table on Refrigerant Quantity in KHY 12 and 15 kW Units

| Model | Refrigerant | |
|-------|-------------|---------------------------------------|
| | kg | Equivalent to tons of CO ₂ |
| 12 kW | 0,85 | 0,0026 |
| 15 kW | 1,30 | 0,0039 |



The refrigerant R290 is flammable and explosive. Installation in environment where there are active or potential sources of ignition is strictly prohibited.

2.3. Maintenance

Precautions for daily use. Proper operation of a heat pump based on R290 refrigerant requires special precautions to ensure safety. Propane is a flammable substance, so it is necessary to observe certain rules to ensure safe use.

- 1. Ventilation:** Make sure the heat pump has adequate ventilation. The device should be installed in a well-ventilated room to avoid the accumulation of potential gas leaks.
- 2. No sources of ignition:** In the vicinity of the R290 heat pump, avoid sources of fire such as open flames, hot objects, or electrical equipment that does not meet safety standards.
- 3. Regular inspection:** Regularly check the device for leaks, damage, and potential leaks. If you notice any irregularities, immediately turn off the heat pump, ventilate the room, and contact the manufacturer.
- 4. Repair:** If there is a malfunction, hire an experienced technician with the appropriate qualifications, knowledge, and manufacturer's authorization to repair it.
- 5. Safe storage:** Strictly prohibit the storage of flammable substances near the heat pump. If you have such substances, make sure they are safely closed and stored away from the device.
- 6. Knowledge of the device:** Familiarize yourself with the heat pump user manual. Understanding its operation and safety principles will help you avoid dangers associated with improper use.
- 7. Call for help:** If you detect a characteristic gas smell, experience dizziness, difficulty breathing, or other alarming symptoms, immediately move away from the device, turn off the heat pump power source, and contact the service.

Observing these precautions is extremely important for ensuring safe use of a heat pump based on R290 refrigerant.

| |
|--|
| <p>Before the initial operation of the device or after a longer pause, perform the following preparations:</p> <p>(1) Thoroughly inspect and clean the device.</p> <p>(2) Clean the water installation - mesh filter, magnetic separator.</p> <p>(3) Check the water pump, regulating valve, and other equipment of the water installation.</p> <p>(4) Tighten all hose connections.</p> <p>(5) Verify if the pressure in the installation is appropriate.</p> |
| <p>Do not change system parameters without consulting an engineer.</p> |
| <p>Ensure that the water filling and draining device is functioning properly; otherwise, the efficiency and reliability of the device may be compromised.</p> |
| <p>Ensure that the water installations are clean and avoid any dirt or blockages.</p> |
| <p>Check the current, water, and replace faulty parts at appropriate intervals. Use parts provided or recommended by the manufacturer, and avoid using non-original parts.</p> |
| <p>If refrigerant needs to be replenished due to a leak, contact the service or sales representatives.</p> |

Periodic maintenance (every 12 months) is a requirement to maintain the warranty!

| | |
|---|--|
| <p>Preparation</p> | <p>Before performing maintenance, make sure that the device has stopped working and disconnect the power supply.</p> |
| <p>Inspection and Cleaning of the Finned Heat Exchanger</p> | <p>To maintain the optimal heat exchange efficiency of the heat exchangers, their surfaces must be kept clean.</p> |
| <p>Inspection and Cleaning of Plate Heat Exchanger</p> | <p>Every 12 months or if the device's performance drops by more than 10%, you should inspect the water heat exchanger for the presence of scale, and if necessary, clean the heat exchanger.</p> |
| <p>Check the electrical wiring.</p> | <p>Check if the contact point at the connection of the power cables is not loose, oxidized, or blocked by other objects, etc.</p> |

2.4. Inspection

2.4.1 Preparation for Inspection and Maintenance



WARNING

Hazard!

Risk of death due to fire or explosion in case of refrigerant leakage!

- The work can only be carried out by an authorized and competent person with good knowledge of the special properties and hazards associated with the refrigerant R290.
- The product contains the flammable refrigerant R290. In the event of a leak, the released refrigerant may mix with the air, creating a flammable atmosphere.
- There is a risk of fire and explosion.
- The space around the device must be adequately ventilated.
- Before starting any maintenance, servicing, or replacement work, adhere to basic safety principles.
- Disconnect the device from the power supply and ensure that the product is properly grounded.

2.4.2. Cleaning the device

- Do not clean the product with a high-pressure washer or direct water stream.
- Clean the product with water and a cleaning agent added
- Do not use abrasive cleaning agents. Do not use solvents. Do not use cleaning agents containing chlorine or ammonia.
- Check for dirt between the fins of the heat exchanger or if deposits have adhered to the fins.
- Clean the fins using a soft brush, avoiding bending the fins.
- Check if dirt has accumulated in the condensate drip tray or in the drain pipe.
- Check if water is not accumulating in the tray and can flow freely.

2.5. Moving

Due to the relatively large size and weight of the unit, it can only be moved using lifting equipment with proper suspension. Below are some steps to consider during the heat pump transportation process:

1. Preparation: Ensure that you have access to a crane and necessary tools and equipment that will enable the safe transportation of the heat pump.
2. Shutdown of the device: Before the transportation process, make sure that the heat pump is turned off and disconnected from the power source.
3. Professional crane operator: Only work with a qualified crane operator who has experience in moving heavy equipment. The operator should follow safety procedures and be cautious during transportation.
4. Secure fastening: The heat pump must be securely fastened to the crane hook to avoid displacement or falling during transport.
5. Ground stability: Ensure that the destination where the heat pump will be moved to is properly

prepared and stable. Avoid areas with inclines and obstacles that could make transportation difficult.

6. Positioning in the new location: After transporting the heat pump to a new location, ensure that it is placed on a stable surface and is level. Perform a visual inspection to eliminate any damages.
7. Moving the heat pump using a crane is a process that should only be carried out by professionals. Exercising caution and following safety procedures is crucial for ensuring efficiency and safety during this process.



CAUTION

To avoid damage, do not touch the air inlet or the aluminum fins of the unit.

Do not use clamps on the ventilation grilles to avoid damaging the units.

The unit is heavy! Prevent the device from falling due to improper tilting during transportation.

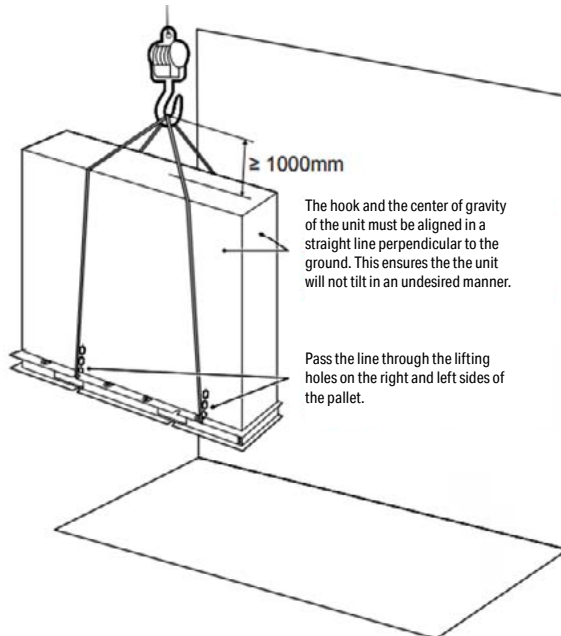

3. Technical information

3.1. Accessories

| Name | Shape | Quantity |
|----------------------|---|----------|
| User Manual |  | 1 |
| Vibration dampers |  | 4 |
| Screws |  | 4 |
| Signal cable |  | 1 |
| Wired control remote |  | 1 |
| Temperature sensor |  | 1 |
| Drain connector |  | 1 |
| Energy labelling |  | 1 |

3.2. Dimensions of units

3.2.1. KHY-12PY3



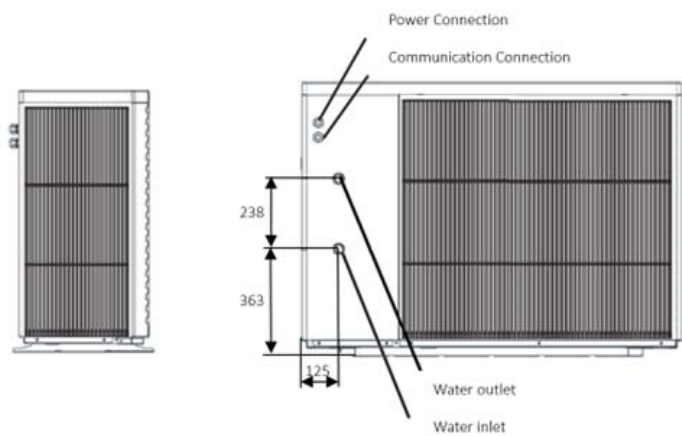
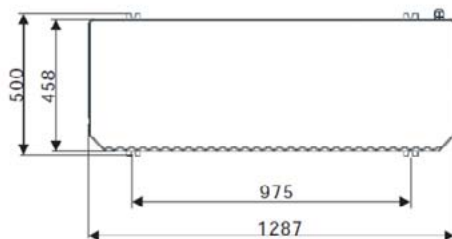
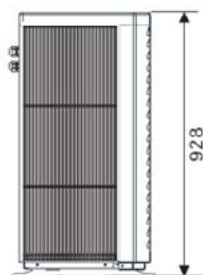
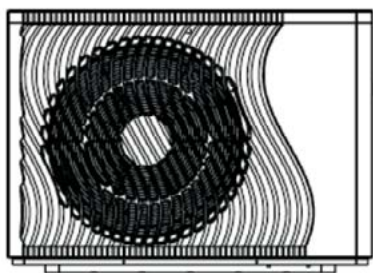

3.2.2. KHY-15PY3

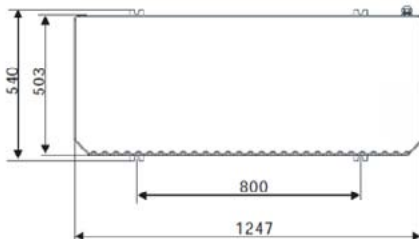
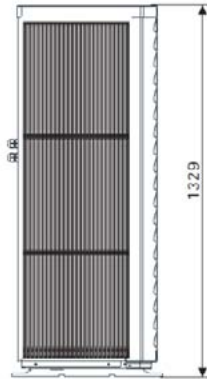
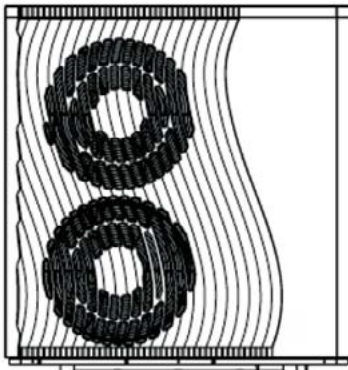

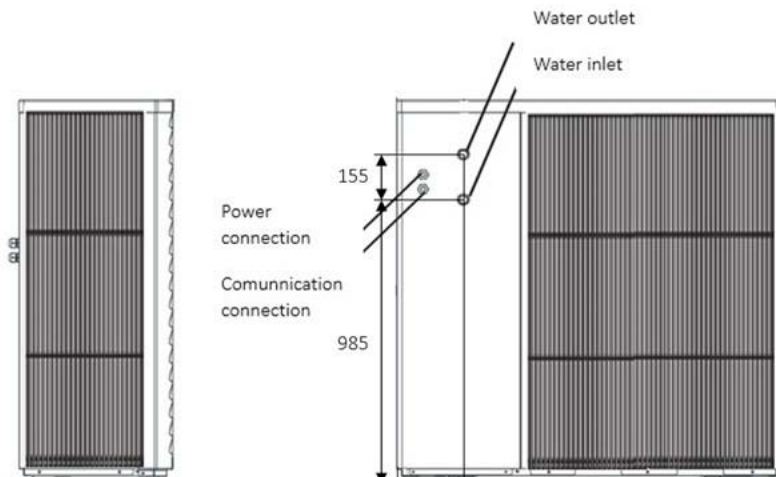

3.3 Basic parameters

| Parameter | Unit | KHY-12PY3 | KHY-15PY3 |
|---|-------------------|-------------------|-------------------|
| Power Supply | V | 380 415V/3N~/50Hz | 380 415V/3N~/50Hz |
| Heating Mode Operating Range | °C | -25 to +43 | -25 to +43 |
| Maximum Heating Fluid Supply Temperature | °C | 75 | 75 |
| Quantity of refrigerant R290 | kg | 0,85 | 1.30 |
| Sound Power Level | dB(A) | 58 | 62 |
| Maximum Current | A | 10,5 | 15,8 |
| Maximum Electrical Power | kW | 5,3 | 9.0 |
| Nominal Heating Flow Rate | m ³ /h | 1,7 | 2,9 |
| Internal Flow Resistance of the Heating Fluid Through the Heat Pump | kPa | 20 | 20 |
| Circulation Pump Lift Height | mH ₂ O | 7,5 | 12,5 |
| Water Connection | Inch | 1 F | 1 F |
| Device Dimensions | mm | 1287x488x928 | 1247x503x1329 |
| Device Weight | kg | 160 | 202 |

3.4. Performance Tables

Performance Tables of KHY Series Heat Pumps. The following tables include the operating parameters of KHY Series heat pumps based on the outside temperature and the desired water outlet temperature from the heat pump. The charts illustrate the relationships between heating capacity and coefficient of performance with respect to the ambient temperature. Parameters are provided for the water flow rates (FLOW) specified in the tables.

The values presented in the tables and on the charts have been explained in the table below:

| Parameter | Unit | Meaning |
|-----------|------|----------------------------|
| AT | °C | Ambient Temperature |
| HC | kW | Heating Capacity |
| PI | kW | Power Input |
| COP | - | Coefficient of Performance |
| LWT | °C | Leaving Water Temperature |

3.4.1. KHY-12PY3

| KHY-12PY3 | | | | FLOW 1100l/h | | | | | | | | |
|-----------|------------|------|------|--------------|------|------|------------|------|------|------------|------|------|
| AT | LWT = 35°C | | | LWT = 45°C | | | LWT = 55°C | | | LWT = 65°C | | |
| | HC | PI | COP | HC | PI | COP | HC | PI | COP | HC | PI | COP |
| -22 | 7,5 | 3,4 | 2,2 | 7,0 | 3,8 | 1,9 | 6,6 | 4,1 | 1,6 | 3,2 | 3,0 | 1,1 |
| -20 | 7,5 | 3,4 | 2,2 | 7,4 | 3,7 | 2,0 | 7,4 | 4,0 | 1,8 | 4,0 | 3,4 | 1,2 |
| -15 | 8,1 | 3,5 | 2,3 | 7,6 | 3,8 | 1,9 | 8,1 | 3,9 | 2,1 | 5,1 | 4,0 | 1,3 |
| -10 | 9,3 | 3,7 | 2,5 | 8,3 | 3,9 | 2,1 | 8,3 | 4,0 | 2,0 | 6,2 | 4,5 | 1,4 |
| -7 | 10,7 | 3,9 | 2,8 | 9,7 | 4,0 | 2,4 | 8,6 | 4,2 | 2,1 | 6,8 | 4,2 | 1,6 |
| -5 | 10,8 | 3,9 | 2,8 | 9,6 | 4,0 | 2,4 | 8,9 | 4,2 | 2,1 | 7,3 | 4,1 | 1,8 |
| -2 | 11,1 | 3,8 | 2,9 | 9,3 | 3,8 | 2,4 | 8,0 | 4,1 | 2,2 | 7,7 | 4,1 | 1,9 |
| 0 | 11,5 | 3,7 | 3,1 | 9,1 | 3,7 | 2,5 | 7,4 | 4,0 | 2,2 | 8,2 | 4,0 | 2,1 |
| 2 | 8,7 | 3,4 | 2,6 | 9,1 | 3,6 | 2,5 | 8,6 | 3,9 | 2,2 | 8,7 | 4,0 | 2,2 |
| 5 | 11,0 | 3,6 | 3,1 | 10,0 | 3,7 | 2,8 | 9,9 | 4,0 | 2,4 | 9,4 | 4,1 | 2,3 |
| 7 | 13,4 | 3,8 | 3,6 | 10,9 | 3,7 | 2,9 | 11,2 | 4,1 | 2,8 | 10,1 | 4,2 | 2,4 |
| 12 | 14,3 | 3,4 | 4,2 | 12,2 | 3,5 | 3,5 | 10,7 | 3,7 | 2,9 | 10,6 | 3,9 | 2,7 |
| 15 | ---- | ---- | ---- | ---- | ---- | ---- | ---- | ---- | ---- | ---- | ---- | ---- |

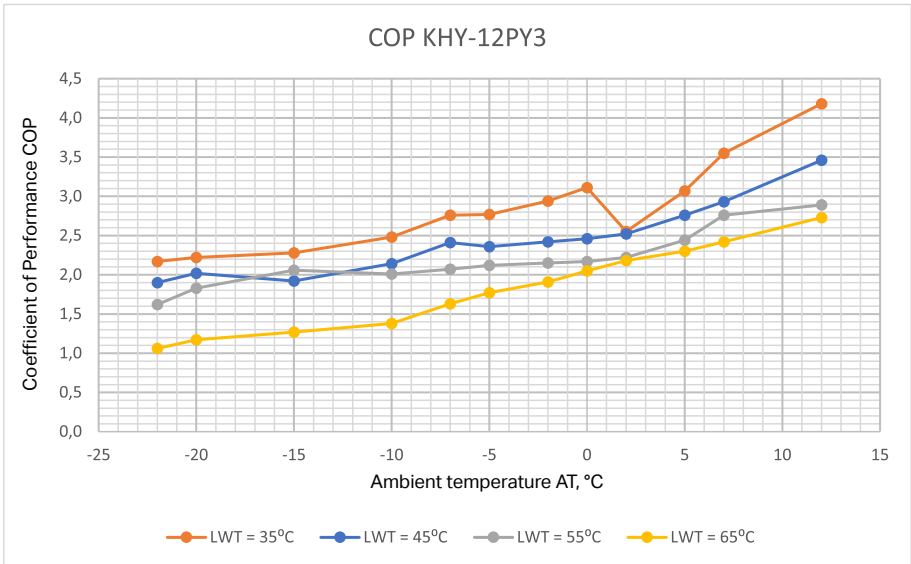
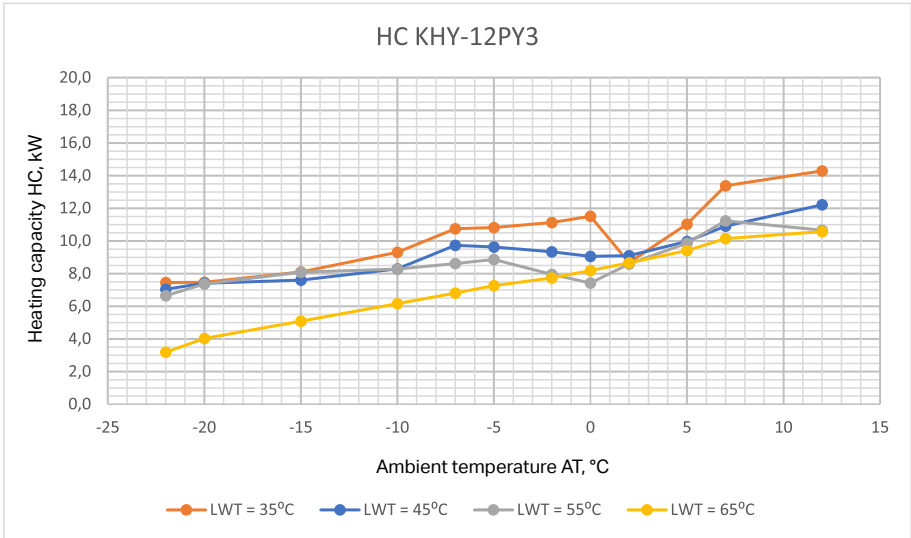

| KHY-15PY3 | | | | FLOW 2200l/h | | | | | | | | |
|-----------|------------|------|------|--------------|------|------|------------|------|------|------------|------|------|
| AT | LWT = 35°C | | | LWT = 45°C | | | LWT = 55°C | | | LWT = 65°C | | |
| | HC | PI | COP | HC | PI | COP | HC | PI | COP | HC | PI | COP |
| -22 | 9,6 | 5,9 | 1,6 | 9,7 | 6,7 | 1,4 | 8,8 | 7,5 | 1,2 | 8,0 | 7,3 | 1,1 |
| -20 | 10,5 | 5,2 | 1,9 | 10,3 | 5,9 | 1,7 | 10,2 | 6,7 | 1,5 | 8,5 | 6,1 | 1,4 |
| -15 | 12,0 | 5,5 | 2,1 | 12,0 | 6,3 | 1,8 | 10,3 | 6,8 | 1,4 | 9,5 | 7,3 | 1,3 |
| -10 | 13,3 | 5,7 | 2,2 | 12,7 | 5,9 | 2,1 | 11,3 | 6,0 | 1,8 | 10,4 | 6,3 | 1,6 |
| -7 | 14,3 | 5,7 | 2,4 | 13,1 | 5,9 | 2,1 | 12,1 | 6,1 | 2,0 | 10,9 | 6,4 | 1,6 |
| -5 | 15,3 | 5,7 | 2,5 | 13,5 | 5,9 | 2,2 | 13,3 | 6,2 | 2,1 | 11,3 | 6,4 | 1,7 |
| -2 | 14,7 | 5,4 | 2,6 | 13,7 | 5,7 | 2,3 | 12,6 | 5,9 | 2,0 | 11,9 | 6,3 | 1,8 |
| 0 | 14,4 | 5,2 | 2,6 | 14,2 | 5,5 | 2,4 | 12,3 | 5,7 | 2,1 | 12,4 | 6,1 | 1,9 |
| 2 | 15,3 | 5,3 | 2,8 | 14,6 | 5,1 | 2,8 | 14,6 | 5,9 | 2,4 | 12,7 | 6,1 | 2,0 |
| 5 | 17,3 | 5,4 | 3,1 | 15,2 | 5,1 | 2,8 | 15,1 | 6,0 | 2,4 | 16,1 | 7,2 | 2,1 |
| 7 | 18,6 | 5,4 | 3,2 | 16,4 | 5,2 | 3,0 | 16,6 | 6,0 | 2,6 | 19,5 | 8,3 | 2,2 |
| 12 | 20,6 | 5,6 | 3,5 | 18,4 | 5,3 | 3,3 | 18,8 | 5,8 | 3,1 | 24,1 | 9,3 | 2,6 |
| 15 | ---- | ---- | ---- | ---- | ---- | ---- | ---- | ---- | ---- | ---- | ---- | ---- |

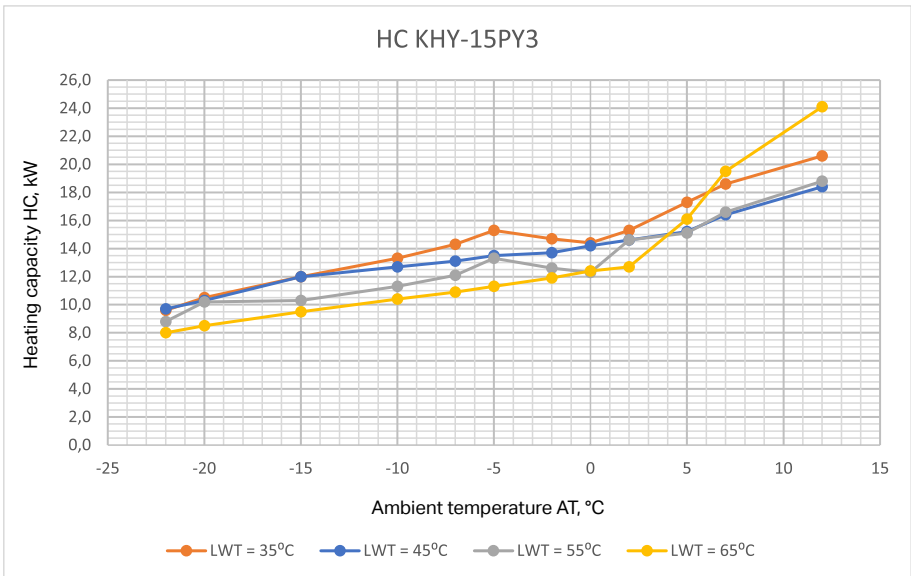

COP KHY-15PY3

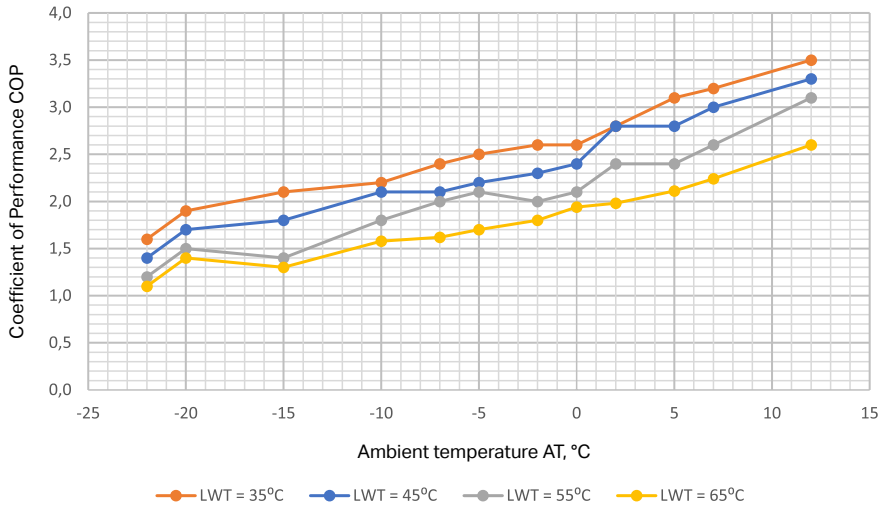

3.7. Schematic diagram of the installation layout.

The provided schematic diagram is for illustrative purposes only. The heat pump and all other components of the system should be selected and designed by an experienced installer specifically for the user's existing setup.

The monoblock heat pump comes equipped with an integrated main circulation pump. During installation, installers should connect the heat pump to other components of the system, such as a buffer tank (for heating/cooling of spaces), a domestic hot water tank (for hot water supply), and water circulation pumps (for circulating water for space heating/cooling and domestic hot water). Depending on the application, external fittings may also be required, including a safety valve, a water filling valve, and three-way and mixing valves. A temperature sensor should be placed in the domestic hot water tank. An additional electric heating element can be installed in the domestic hot water tank or buffer tank, which can receive control signals from the heat pump.

Please note that the specific installation layout and components will vary based on the user's needs and the existing infrastructure. It is recommended to work with a qualified installer to design and implement a system that meets your requirements and ensures efficient operation.

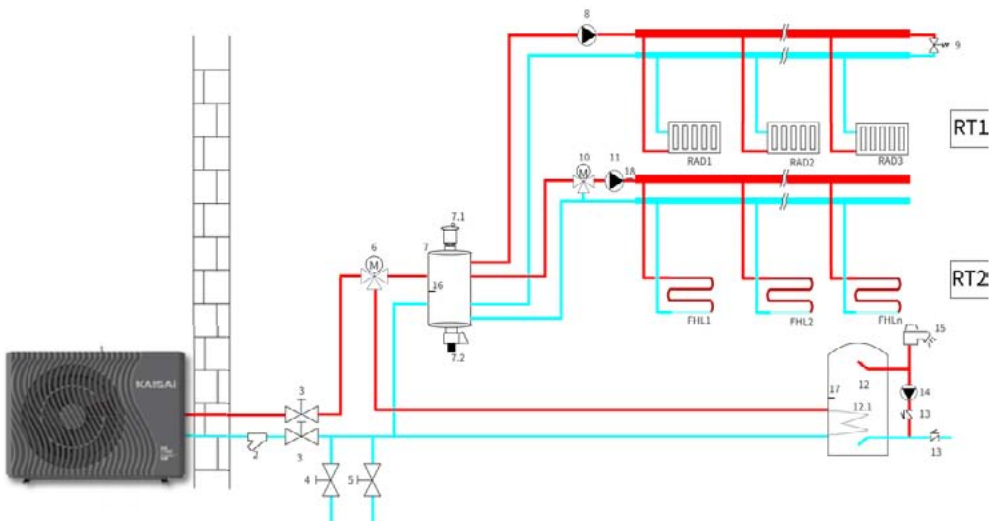

Application (illustrative diagram)

| Code | Element | Code | Element |
|-------------|--|-------------|--|
| 1 | Heat pump | 11 | K15:Circulation pump for the second circuit |
| 2 | Filter | 12 | Domestic hot water tank |
| 3 | Shut-off valves | 12.1 | Heat exchanger (coil) in the domestic hot water tank |
| 4 | Drain valve | 13 | Check valve |
| 5 | Filling valve | 14 | K5: Hot water circulation pump |
| 6 | K9: Three-way switching valve for heating/domestic hot water | 15 | Hot water tap |
| 7 | Buffer tank | 16 | BT: Buffer temperature sensor (optional) |
| 7.1 | Air vent | 17 | TT: Hot water tank temperature sensor |
| 7.2 | Drain valve | 18 | Temperature sensor for the mixing unit of the second circuit |
| 8 | K14: external circulation pump | 19 | Additional heat source/electric heater |
| 9 | Pressure relief valve | RAD 1...n | 1 heating circuit/radiator circuit |
| 10 | Two-way mixing valve | FHL 1...n | 2 heating circuit/ floor heating |
| 11 | K15: Secondary circuit circulation pump | | |

The heat pump allows you to control (see the mainboard diagram):

- 3-way valve switching heating/DHW
- 2-way mixing valve for the 2nd circuit
- Circulation pump for the 1st circuit
- Circulation pump for the 2nd circuit
- Circulation pump for DHW
- Electric heaters as additional heat sources (3 stages)

In the 'Electrical Connections' section, the wiring diagrams for the mainboard and other components are provided.

4. Unit inspection

4.1. Before installation

4.1.1. Proper heat pump selection

Selecting the right heat pump for a building is a crucial step that affects the efficiency and performance of the heating system. Here are some steps to consider when choosing a heat pump for a building:

1. Heating demand: Accurately assess the heating demand of the building based on its surface, thermal insulation, and other characteristics. This will help in choosing a heat pump with appropriate power to ensure efficient heating and hot water production.
2. Climatic conditions: Knowledge of average temperature and weather conditions in the vicinity of the building is essential. The monoblock air-water heat pump uses thermal energy from the air, so its performance is dependent on ambient temperature.
3. Operating temperature: R290 (propane) is a refrigerant with a low boiling point. Knowing the operating temperature range of the heat pump in different scenarios is critical to ensure its performance, especially in periods of lower temperatures.
4. Technical parameters: Examine the technical parameters of the heat pump, such as heating efficiency, electrical power, operating temperature range, and adjustability to meet the building's needs.
5. Installation and positioning: Ensure that the heat pump is compatible with the building's heating system and that there are appropriate conditions for its installation.
6. Safety: Due to the use of R290 refrigerant, remember to take appropriate safety measures during heat pump installation and operation. Proper ventilation and safety measures are essential.
7. Future needs: Anticipate future changes in the building, such as increasing heating demand or expansion.

In conclusion, selecting a monoblock air-water heat pump with R290 refrigerant should consider the technical parameters of the device, building's characteristics, and climatic conditions. Choose the appropriate device model and other system components in accordance with technical knowledge and applicable standards. Cooperation with heat pump installation experts can significantly facilitate making the right choice.

4.1.2. Application

- Heat pumps are used for heating/cooling and domestic hot water production. Heating can be done using fan coil units, underfloor heating, and high-efficiency low-29 temperature radiators. Cooling can only be done through fan coil units. Domestic hot water is heated by the heat pump working in conjunction with water heaters, tanks, and other devices with an appropriate heat exchange surface.

- An auxiliary heater (peak heat source) is required. It provides higher heating efficiency at low outside temperatures. The auxiliary heater is also used in case of a refrigeration system failure and to protect against freezing of the external piping during the winter season.

4.1.3. Electric heater

The manufacturer requires the use of an electric heater or another peak heat source needed to start the heat pump with a minimum heating capacity of 6 kW.

The additional electric heater mounted on the hydraulic system primarily serves the purpose of protecting the system. Its presence is necessary in several different situations:

1. Startup in low temperatures: During low outside temperatures, the heat pump may encounter difficulties in starting up or achieving sufficient heating efficiency. The electric heater supports the heat pump in these conditions, providing quick and effective heating.
2. Refrigeration system failure: In case of a failure or malfunction of the heat pump's refrigeration system, the electric heater can take over the heating function to maintain thermal comfort in the building.
3. Heating the system: The heater can be used to heat up the hydraulic system before starting the heat pump's normal operation. This helps prevent low temperatures at the beginning of heating.
4. Support in extreme conditions: In situations where the outside temperature is extremely low and the heat pump's efficiency may be limited, the electric heater increases the possibility of achieving the required level of heat.

| The heat pump model | KHY-12PY3 | KHY-15PY3 |
|---|------------------|------------------|
| Heating element power as additional heat source (AHS) | 6.0kW;400V | 6.0kW;400V |

Required minimum electric heating power.

4.1.4. Boiler water

The boiler water used in a heat pump installation plays an important role as it affects the system's efficiency and durability. Here are some key characteristics worth considering when adjusting the boiler water for a heat pump installation:

Cleanliness: The boiler water should be clean and free from impurities, deposits, and minerals, which can negatively affect the heat exchanger's performance in the heat pump.

Mineral content: The boiler water should have low mineral content, such as calcium, magnesium, or iron. High levels of these minerals can lead to boiler scaling and reduce the heat pump's efficiency.

Hardness: Water hardness is a measure of the mineral content in the water. Too hard water can cause scaling, which restricts the heat flow in the heat exchanger.

pH: The pH value of the boiler water should be balanced to prevent corrosion or scaling in the installation. The optimal pH range is from 7 to 8.

Suitable corrosion inhibitors: The boiler water may contain anti-corrosion and scale inhibitors, which help maintain the system's cleanliness and efficiency.

Suitable freezing temperature: According to Polish Standard Norm (PN) and National Technical Standard (PN-EN), requirements are set for water installations, including those designed to protect against water freezing in the installation.

"Elements of water heating installations, exposed to intense inflow of external air in winter, should be protected against freezing and, where necessary, have thermal insulation protecting against excessive heat loss."

The installation should be protected against freezing in case of a device power outage.

Regular inspections and maintenance: It is essential to regularly monitor the water quality and conduct periodic inspections to maintain optimal water quality and the system's efficiency.

Water should not be softened below 3.5°dH. Water that is too soft can damage the installation.

| Parameter | Limitations for tap water |
|------------------|--|
| Temperature | Below 60°C |
| pH level | 7-9 |
| Alkalinity | 60mg/l HCO_3^- <math>< 300\text{ mg/l}</math> |
| Guidance | <math>< 500\mu\text{S/cm}</math> |
| Hardness | From 3,4 to 8,4°dH |
| Chloride content | <math>< 200\text{mg/l}</math> w 60°C |
| Sulfate content | <math>[SO_4] < 100\text{mg/l}</math> i $[HCO_3]/[SO_4^2] > 1$ |
| Nitrate content | <math>NO_3 < 100\text{ mg/l}</math> |
| Chlorine content | <math>< 0,5\text{ mg/l}</math> |

4.1.5. Flushing the plumbing system

The manufacturer requires performing flushing of the hydraulic system and using a corrosion inhibitor.

- Chemical cleaning and flushing of the central heating system involve passing a mixture of chemicals through the system to dissolve accumulated deposits. The chemical mixture also contains corrosion inhibitors, which reduce the corrosion rate and limit the deposition of sediment, thereby extending the lifespan of the installation.
- Components of the heating system are exposed to natural destructive processes. The most dangerous is the corrosion of metal elements. Over time, rust leads to material damage and the need for repair of the device or installation. The manufacturer recommends the use of corrosion inhibitors as intended in central heating systems with a heat pump.

4.1.6. Magnetic dirt separator

A magnetic separator captures ferromagnetic impurities in the installation, improving water quality in the heating system and extending the lifespan of heating equipment and fittings.

Modern heating equipment is becoming increasingly precise and, therefore, more sensitive to impurities. That is why attention should be paid to the quality of the heating agent, whether it is water or a glycol-water mixture. For many reasons, it is essential to protect components as well as the entire installation from impurities in heating system agents.

A compact magnetic separator enables the separation and elimination of impurities from hydraulic systems in modern heating systems. The manufacturer recommends using the separator in every heating installation with water-based underfloor heating or radiator heating working with a heat pump. The device aims to extend the lifespan of the heat source and the installation fittings.

It is essential to choose a magnetic separator with the appropriate Kv value since the volumetric flow rate influences the efficiency of separating impurities. The correctly selected magnetic separator must handle liquid flow (a nominal flow rate through the heat pump) in the installation while effectively capturing impurities.

The manufacturer requires mandatory use of a mesh filter. Failure to use the mesh filter results in the loss of the equipment warranty. It is recommended to use filters with an additional magnetic insert. The use of a magnetic impurity separator does not exempt one from the obligation to use the mesh filter.

- Location of magnetic separator

The components of the heating system are susceptible to natural destructive processes. Rusting of metal elements is particularly dangerous. Over time, corrosion leads to material damage and the need for equipment or installation repairs. The manufacturer recommends the use of corrosion inhibitors according to their intended purpose in central heating systems with heat pumps.

Inhibitors play a crucial role in preventing corrosion within the heating system by forming a protective layer on the metal surfaces. This protective layer acts as a barrier between the metal and the corrosive elements present in the water, reducing the risk of rusting and deterioration. By using corrosion inhibitors as recommended by the manufacturer, you can help prolong the lifespan of your heating system and ensure its reliable performance over time.

4.1.7. Vibration isolation

The manufacturer recommends the use of vibration isolation.

The most effective way to eliminate vibrations is to isolate the vibrating unit from the ground using vibration isolators, which should be selected specifically for the mounted device.

Appropriately chosen vibro-acoustic isolators should be placed directly between the supporting structure and the device. In this case, isolators can effectively absorb up to 99% of the generated vibrations.

4.1.8. Buffer tank

A heat buffer connected in parallel is required in a central heating system. The heat buffer serves as a heat storage unit that helps to even out fluctuations in heat production and consumption in a heat pump system. This contributes to improving the efficiency, comfort, and durability of the entire heating system. The buffer is designed to provide the proper water charge in the system which is necessary during the defrosting process of the heat exchanger. The buffer also allows for the balancing of heat production and consumption as well as reducing the cycling of turning on and off the equipment. These cycles can lead to greater energy consumption and mechanical wear. The heat buffer can reduce the frequency of these cycles, maintaining a constant temperature inside the tank. Additionally, the parallel connection separates the heat pump and heating system circuits, resulting in greater certainty of achieving the nominal water flow rate through the device. For atypical installations, a buffer tank installation in a series connection is allowed after consultation with the manufacturer.

The recommended capacity of the buffer tank is shown in the following table.

| Model of heat pump | | KHY-12PY3 | KHY-15PY3 |
|---------------------------|---|------------------|------------------|
| Buffer tank capacity | l | 200-300 | 250-400 |

4.1.9. Domestic hot water tank

The domestic hot water (DHW) tank in a heat pump system plays a significant role in providing hot water for household use. Here are some guidelines to consider when selecting and configuring a DHW tank in such an installation:

Tank capacity: The selection of DHW tank capacity should be tailored to the household's needs, which depend on the number of people using hot water. Too small a tank capacity can lead to a lack of hot water, while too large a capacity can result in excessive heat losses.

Thermal insulation: The DHW tank should be adequately insulated to reduce heat losses. A well-insulated tank retains water temperature for a longer time, leading to energy savings.

The domestic hot water tank should have a larger surface area of the heat exchanger (coil) compared to high-temperature devices (e.g., coal boiler). This allows for quicker heating of the tank to the desired temperature and speeds up the switching process of the 3-way valve to heating mode.

Compliance with standards and regulations: The DHW tank should meet applicable standards and regulations concerning water and heating installations.

Minimum coil surface areas are provided in the table below:

| The heat pump model | | KHY-12PY3 | KHY-15PY3 |
|---|----------------|-----------|-----------|
| The heat exchange surface area (stainless steel coil) | m ² | 1,90 | 2,80 |
| The heat exchange surface area (enamel-coated coil) | m ² | 2,8 | 3,2 |

4.2. Installation location

4.2.1. Device Placement

The heat pump can be installed on a concrete foundation using expansion bolts with rubber anti-vibration washers or on bituminous feet, as well as on a steel frame with rubber feet, allowing it to be placed above ground. It is important to ensure that the unit is set parallel to the ground.

The device must be installed at least 400 mm above the ground.

In the case of heat pumps installed outdoors, precautions should be taken to prevent refrigerant leakage from entering the building in case of a leak. It should also be ensured that no individuals outside or in neighboring buildings are exposed to danger in the event of refrigerant leakage. The heat pump manufacturer specifies safety zones. In these safety zones, there should be no permanent or short-term ignition sources such as:

- open flames
- electrical installations, sockets, lamps, light switches,
- building electrical connections,
- spark-generating tools,
- objects with high surface temperatures, e.g., ~360°C.

The safety zones defined by the manufacturer must be maintained at all times, and the user is responsible for this. The definitions of safety zones generally look like the diagrams below:

The minimum distance from ignition sources should be at a minimum level (1000mm).

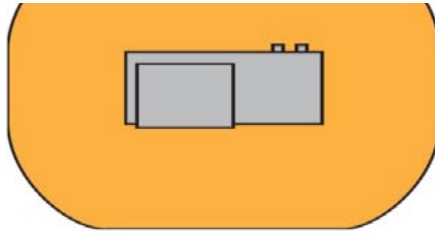

Protective zone, installation away from the building.

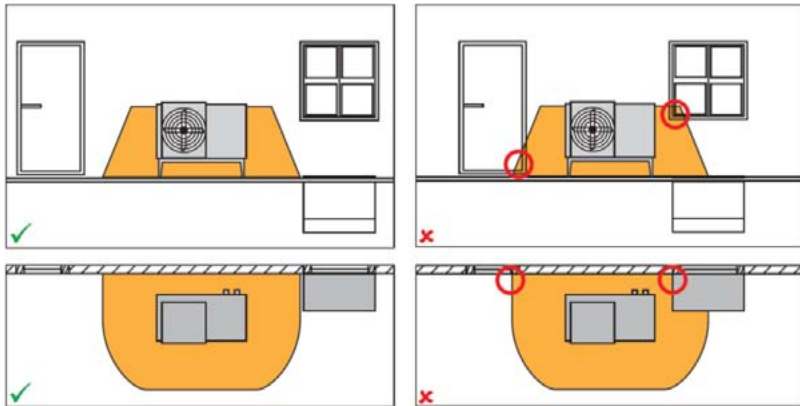

Protective zone in case of locating near the wall.

Within the protective zones, there should be no:

- Building openings
- Windows
- Doors
- Skylights
- Roof windows
- Openings of ventilation systems
- Property boundaries or neighboring properties, walkways, driveways, ground depressions,
- Wells, sewer drains, etc.

To ensure access for maintenance, servicing, etc., it is necessary to follow the manufacturer's specifications regarding minimum clearances during installation.

Protective zones must be considered independently of these minimum clearances.

- The unit contains flammable refrigerant, so install it in a well-ventilated area. If you are installing the unit indoors, implement additional refrigerant leak detection devices and additional ventilation equipment (devices must comply with EN378 standards). Make sure to implement measures that prevent small animals from entering the unit.
- Small animals, when in contact with electrical components, can cause malfunctions, smoke, or fire. Advise the customer to maintain cleanliness around the unit.
- Choose an installation location that meets the mentioned criteria and complies with customer requirements:
 - Well-ventilated areas.
 - Places where the unit will not disturb neighbors.
 - Safe places where the weight and vibrations of the unit are not a problem, and the unit can be leveled.
 - Places where there is no risk of flammable gas leakage or product leakage.
 - The equipment is not suitable for use in hazardous areas.
 - Places where installation and servicing of the device will be possible.
 - Places where the lengths of piping and wiring for the unit will fit within specified limits.
 - Places where a water leak from the unit will not cause damage (e.g., in the case of a blocked drain pipe).
 - Places where contact with rain is minimized as much as possible.
 - Do not install the unit in areas frequented by workers. In the case of construction work (e.g., grinding) that generates a lot of dust, cover the unit.
 - Do not place objects or equipment on top of the unit (applies to the top plate).
 - Do not climb on the unit, sit, or stand on its top.
 - Ensure that appropriate remedial measures are taken in case of refrigerant leaks in accordance with applicable law.
 - Do not install the unit near the sea or in places where it will come into contact with corrosive gases.
 - If the unit is in a location exposed to strong winds, pay special attention to the following issues.

Strong winds reaching a speed of 5 m/s directed opposite to the air outlet of the unit can cause short-circuits and:

- A decrease in operational power.
- Frequent freezing during heating.
- Disruptions in operation due to high pressure.
- In the case of strong, constantly blowing winds from the front of the unit, the fan may rotate very fast until it fails.

Under normal conditions, the unit should be installed according to the following data:

| Model | A (mm) | B (mm) | C (mm) | D (mm) |
|---|---------------|---------------|---------------|---------------|
| KHY-12PY3 | ≥500 | ≥1500 | ≥1000 | ≥500 |
| KHY-15PY3 | ≥500 | ≥1500 | ≥1000 | ≥500 |
| The minimum height of the unit from the ground. | ≥400 | ≥400 | ≥400 | ≥400 |

The table of minimum distances of the outdoor unit from barriers and the ground.

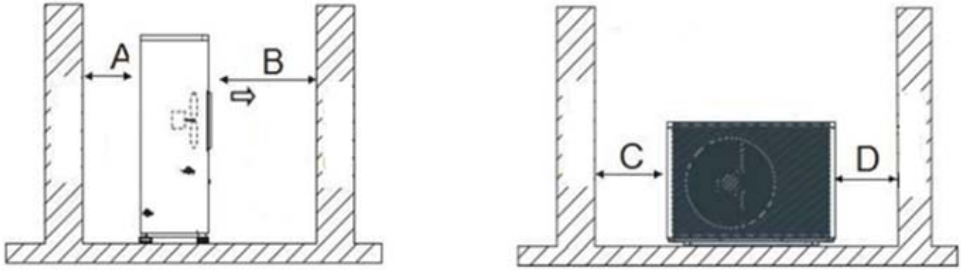

The drawing shows the location of the unit.

Unit (mm)

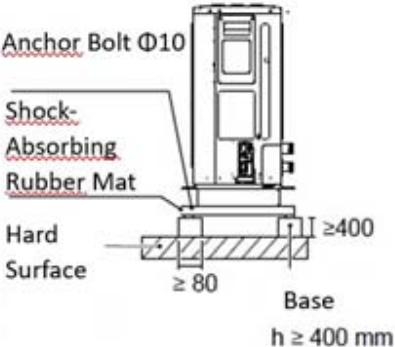

Preview drawing of the installation of the outdoor unit anchored to the ground.

- Prepare a drainage channel around the foundation to divert condensation and any other used water from the vicinity of the unit.
- If water cannot be easily drained from the unit, install the unit on concrete blocks (the foundation height must be at least 400 mm).
- When installing the unit in an area prone to snowfall, ensure that the foundations are as high as possible, at least 400mm above the ground.
- The manufacturer does not recommend mounting the heat pump on the building facade due to the transmission of vibrations to the building structure.



The manufacturer does not recommend mounting the device on the building facade.

4.2.2. Choosing a Location in Cold Conditions

To prevent exposure to wind, install the unit with the suction side facing the wall.

- Never install the unit in a location where the suction side is facing the wind.
- In areas with heavy snowfall, choose a mounting location where the unit will be free from snow. If snow can reach the unit from the side, make sure that the heat exchanger coil does not come into contact with it (if necessary, install a side shield).
- If the device is exposed to heavy precipitation, install a canopy over the heat pump, while maintaining service space (at least 500 mm from the top cover of the unit).

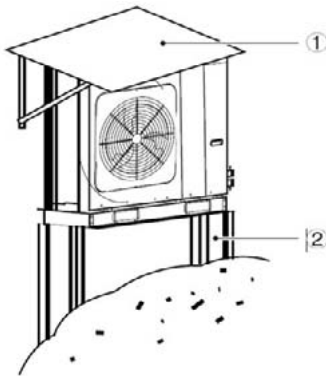

1. Build canopy.
2. Build a platform.

Install the unit high enough to prevent it from being buried in snow, with a minimum height of 400 mm above the ground.

4.2.3. Location in hot climates

The outdoor temperature is measured by a thermistor located in the outdoor unit, so it is important to ensure that the outdoor unit is installed in the shade or under a canopy to avoid direct sunlight. If this is not possible, the unit should be adequately protected.

4.3. Hydraulic connections

All hydraulic connections should be made by an experienced installer/plumber. Please pay attention to the following issues:

- The water circuit must comply with national regulations and building codes.
- The hydraulic installation must be clean, free from dirt, and elements that could clog it. A leak test should be performed to ensure there are no water leaks. The hydraulic installation requires the installation of thermal insulation.
- Ensure minimal hydraulic resistance in the water installation to maintain nominal water flow through the heat pump. A flow rate that is too low in the heat pump system will void the warranty. The flow rate must not be less than nominal (depending on the model).
- The leak test of the hydraulic installation should be conducted on the installation itself. DO NOT test it together with the heat pump.

- The water loops should be equipped with expansion tanks and safety valves.
- Do not use crushed or deformed pipes. Using low-quality pipes may lead to pump failure.
- Cover the end of the pipe to prevent dust and dirt from entering after insertion into the wall. When connecting an existing tank to the heat pump, ensure that the pipes are clean.
- To prevent galvanic corrosion, use components of the same metal or alloy of metals and use insulation or dielectric inserts in places where different metals need to be connected.
- The mechanical flow sensor is installed inside the heat pump; ensure that the wiring and its operation are correct and detected by the controller.
- Check for air remaining in the water installation and install air-venting elements at the highest points.
- Provide a minimum surface area for the domestic hot water tank coil.
- Measuring pressure gauges and thermometers allow monitoring and controlling installation parameters such as pressure and temperature.

4.3.1. Selection of hydraulic pipes

The selection of appropriate pipe diameters in a heat pump system is crucial for the efficiency and performance of the entire system. The size of the pipes affects fluid flow and hydraulic resistance. The final choice of pipe diameters will depend on many factors such as the heat pump's capacity, the length of the pipe run, the type of medium (water, glycol), the number of elements connected to the system. It is recommended to oversize pipe diameters to avoid insufficient water flow. It is crucial to select pipes with a large internal diameter. The recommended values below are arbitrary. The final selection of pipe diameters should be based on hydraulic calculations, and the installer should choose fittings in accordance with their experience and knowledge.

| KHY-12PY3 | | | | | |
|----------------------------------|----------------------------------|---------------------------|-------------------------------|----------------------------|----------------------------------|
| The type of pipe material | Flow rate (m³) | Pipe diameter (mm) | Internal diameter (mm) | Flow velocity (m/s) | Line friction losses Pa/m |
| Recommendations | | | | | |
| Pex | 1,7 | 40x4,0 | 32 | 0,60 | 130 |
| Thin-walled steel | 1,7 | 35x1,5 | 32 | 0,60 | 125 |
| Copper | 1,7 | 35x1,5 | 32 | 0,60 | 125 |
| PP | 1,7 | 40x5,5 | 29 | 0,71 | 190 |

| KHY-15PY3 | | | | | |
|----------------------------------|----------------------------------|---------------------------|-------------------------------|----------------------------|----------------------------------|
| The type of pipe material | Flow rate (m³) | Pipe diameter (mm) | Internal diameter (mm) | Flow velocity (m/s) | Line friction losses Pa/m |
| Recommendations | | | | | |
| Pex | 2,9 | 50x4,5 | 41 | 0,62 | 100 |
| Thin-walled steel | 2,9 | 42x1,5 | 39 | 0,68 | 125 |
| Copper | 2,9 | 42x1,5 | 39 | 0,68 | 125 |
| PP | 2,9 | 50x6,9 | 36 | 0,78 | 170 |

4.3.2. 3-way (diverting) valve for heating/hot water (DHW)

In the case of a KHY heat pump, which is used for both heating and domestic hot water (DHW) production, a switching valve should be applied based on the heat pump's operating mode (heating or DHW). A 3-way valve with an electric actuator can be used in installations with heat pumps from the KHY series. Such a valve can be remotely controlled and switched depending on the heat pump's operating mode. This valve allows redirecting the flow of fluid between the heating circuit and the DHW circuit.

When selecting the switching valve, it is essential to check the kVs to ensure that the valve does not create excessive resistance in the water installation. In the heat pump, it is possible to connect a valve with 2-point control (with a constant control voltage on one wire of 230 V). The electrical connection diagram of the valve is shown in the subsection below.

4.3.3. Circulation pumps

The selection of the right circulation pump for a heating system with a heat pump is crucial to ensure the efficiency, performance, and proper operation of the entire system. The circulation pump should be capable of efficiently circulating fluids in the heating circuit. Consider the performance and hydraulic resistance of the entire heating system. Properly selected circulation pump parameters will help overcome the resistance of pipes, valves, and other system components. The circulation pump should generate an appropriate pressure increase to ensure smooth fluid flow throughout the system. Too little pressure increase can lead to insufficient flow, while too much can result in excessive energy consumption.

When selecting a circulation pump, pay attention to its energy efficiency. Pumps with lower energy consumption can contribute to operational cost savings in the system. Ensure that the circulation pump is compatible with the heat pump and other system components. It is worth using professional hydraulic calculations or tools provided by manufacturers to accurately select the circulation pump for the system's needs.

When choosing a circulation pump, consider selecting a model that allows for flow rate adjustment. This will enable you to adapt the flow to changing conditions and demand.

4.3.4. 2-circuit mixing valve

In the case of installations with 2 circuits, it is possible to connect a 2-zone mixing valve to be controlled by the heat pump. To do this, a valve with an electric actuator and 3-point control should be used. These valves have an electric drive that allows for remote and automatic adjustment of fluid flow. They can be integrated with the device's automation systems. The connection diagram is shown in the subsection below.

4.4. Electrical connections



All electrical work must be carried out by an electrician with the appropriate qualifications and authorizations.

To make electrical connections, open the side panel to access the power and control terminals. Connecting the heat pump requires the use of an electrical switchboard that allows you to safely disconnect the power supply to the device. In the case of a heat pump, it is required to equip this switchboard with an overcurrent circuit breaker, the load value of which will be adapted to the requirements of the specific installation. In addition, a 30 mA ground fault circuit interrupter must also be installed to ensure safety.

To make electrical connections, follow these steps:

1. Remove the two mounting screws on the bottom of the right side panel as shown in the illustration.
2. Grasp the handle and slide the right side panel downward to release the latch.
3. Then, pull it outward to remove it.

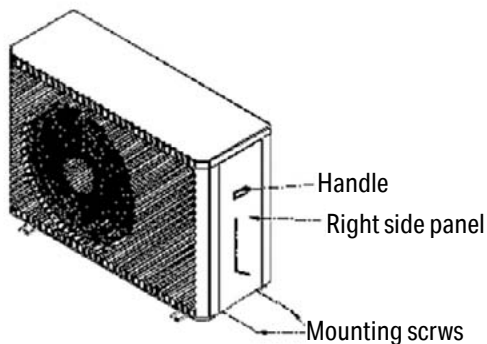

4.4.1. Heat pump power supply

The power supply for the heat pump should be provided through overcurrent protection and residual current protection, as shown below in the diagram and illustration. You should use a cable with a minimum cross-section of $5 \times 4 \text{ mm}^2$ for connecting the device. If the distance between the heat pump and the main distribution board of the building exceeds 20 meters or if additional devices such as an electric heater are planned to be connected, you should appropriately increase the cross-section of the supply cable. It's important to ensure proper phase alignment. Incorrect connection can lead to operational errors or damage to the heat pump after the system is started. The wires should be routed in protective conduits or installation channels. The residual current device (RCD) must be fast-acting (trip time $<0.1 \text{ s}$) for a differential current of 30 mA. The protection should be selected using the table below.

| Parameters | KHY-12PY3 | KHY-15PY3 |
|-----------------------------------|------------------|------------------|
| Power supply | 380-415V/3N/50Hz | 380-415V/3N/50Hz |
| Maximum current, A | 10,5 | 15,8 |
| Maximum electrical power, kW | 5,3 | 9 |
| Circuit breaker, characteristic B | B16A | B16A |
| Power supply cable mm^2 | 5x4 | 5x4 |

When connecting to the power connector, use a round wire connector with insulating housing. Use a power cord that complies with the specifications and connect it properly. To prevent the power cord from being pulled out due to external force, ensure that it is securely fastened. If you cannot use a round wire connector with an insulating housing, make sure of the following: Do not connect two power cords of different diameters to the same power connector (otherwise, loose wiring may cause the wires to overheat). Sample power connections are shown in the diagrams below.

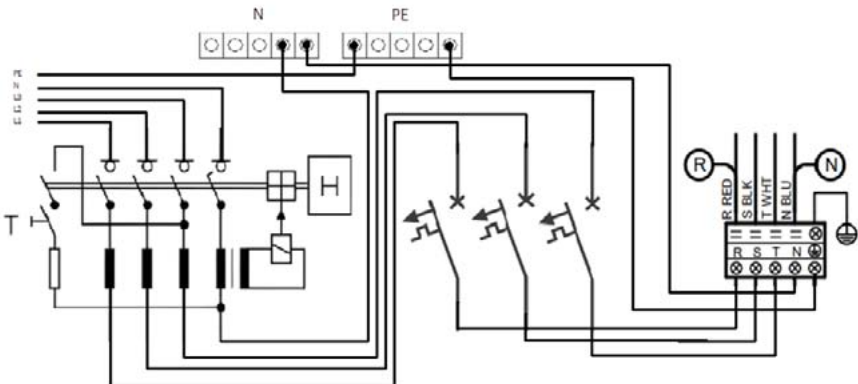

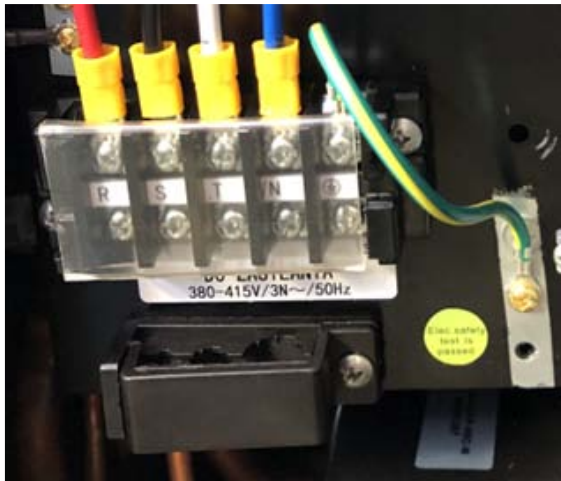
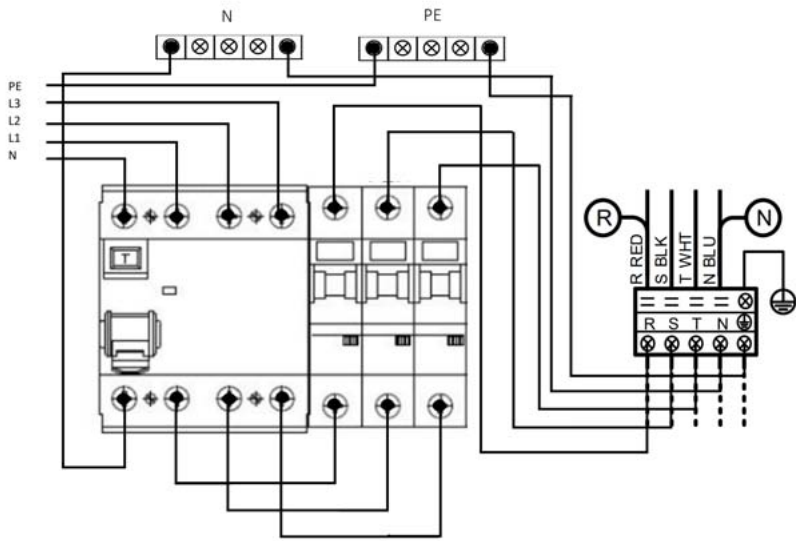

Device power connector

4.4.2. Controller/control panel connection

The control panel comes with a communication cable and prepared connectors. Connect the controller to the connector on the side panel of the device according to the diagram.

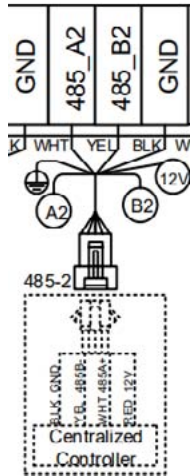

Control panel connector

4.4.3. Temperature sensor/thermostat connection

The device can be controlled based on different temperatures. By default, the heat pump operates based on the water temperature at the heat pump's outlet. It is also possible to operate based on the temperature of the circuits (on the water line), buffer (sensor placed in the buffer tank), and room (thermostats connected to the device). The configuration of the device's operation is controlled by parameters H25 and Z01 (see the Parameters section). Temperature sensors should be connected directly to the mainboard of the device in the following locations:

- DHW tank temperature sensor

The sensor should be connected to terminals 9 and 10 in the connection socket. It is required when the heat pump is to operate in the domestic hot water (DHW) mode. Use a thermistor (temperature-dependent resistor) with a nominal resistance of 6.8 kOhm.

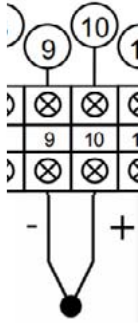

- Buffer tank temperature sensor

The buffer tank temperature sensor allows you to control the operation of the pump by setting parameter H25=2 (see the Parameters section). This sensor is identical to the hot water temperature sensor but connected to terminals 11 and 12 in the connection block.

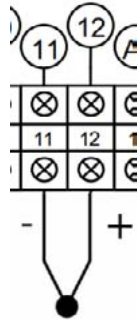

- Temperature sensor for second circuits

In the case of installations with 2 zones, a temperature sensor for the second circuit is required. The sensor should be connected to terminals 36 and 37. A universal NTC sensor with a resistance of 10 kOhms at 25°C should be used for this purpose. This sensor, along with a mixing pump, allows you to control the temperature of the second circuit to the set value.

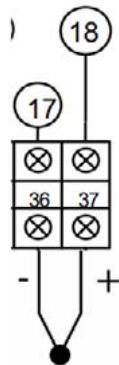

- Temperature sensor/thermostat for the first zone

Depending on the control temperature, you can connect temperature sensor measuring the temperature of the water in the first circuit or thermostat for the first circuit to terminals 34 and 35 on the connection block. Use a universal NTC sensor with a resistance of 10 kOhm at 25°C.

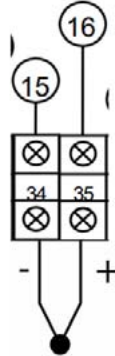

- Temperature sensor/thermostat for the second zone

In a situation where you want to control the operation of the device based on room air temperature, you should connect a thermostat for the second zone to terminals 5 and 6.

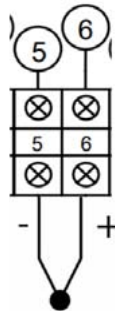

4.4.4. Connection of the Heating/DHW Switching Valve

When the device operates in both heating and domestic hot water modes, you should connect a 3-way valve for switching between modes. Valves with a single power supply line (~230V) can be connected. The connection should be made to terminals 15, 16, and 17 as shown in the diagram below. After connecting the valve, check the polarity and configure parameter H2O accordingly (see Parameters section).

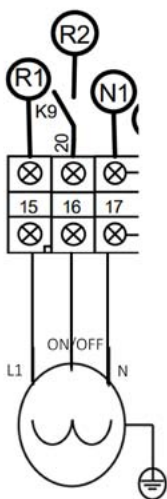

4.4.5. Connection of the 2-Circuit Mixing Valve

The mixing valve controls the temperature of the second circuit to the desired value by opening or closing the mixing. Connect the valve to terminals 31, 32, and 33. The device supplies ~230V to terminal 31 when the temperature is too high, opening the valve to increase mixing and lower the temperature. When the temperature of the second circuit is too low, the device switches the voltage to ~230V at terminal 33 to close the valve. Connect wire N to terminal 32 as shown in the diagram below.

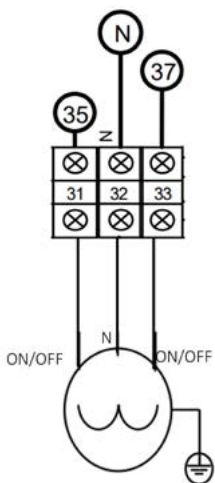

4.4.6. Connection of circulation pumps

The external circulation pumps are responsible for the heating circulation between the buffer tank and the heat emitters. Circulation pumps with a rated power of 150W can be directly connected to the heat pump. For connecting circulation pump 1 in a single-circuit system, you should use terminals 27 and 28. In the case of a two-circuit system, connect circulation pump 2 to terminals 29 and 30. When the conditions for starting the circulation pumps are met, the device will supply a ~230V voltage to terminal 27 for circulation pump 1 and terminal 30 for circulation pump 2. The neutral wires (N) should be connected to terminals 28 and 29. The connection is shown in the diagrams below. To utilize the circulation pumps, you should connect the temperature sensors/thermostats (see the previous subsection) to terminals 34 and 35 for circulation pump 1.

- Circulation pump 1 zone connection diagram

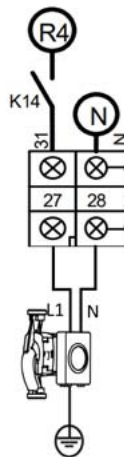

- Circulation pump 2 zone connection diagram

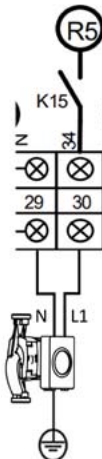

4.4.7. Hot Water Circulation Pump Connection

You can connect the circulation pump with a power of 150W directly to the heat pump. To do this, use terminals 18 and 19. After connecting, configure parameter H40 and set the operating hours and days for the circulation pump. When the conditions for starting the circulation pump are met, the device will provide a voltage of ~230V at terminal 19. Terminal 18 is used for connecting the N wire.

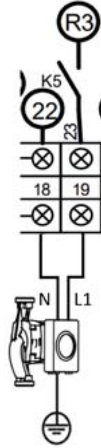

4.4.8. Electric Heater Connection

Electric heaters are required in the installation and are intended to work as peak heat sources. The minimum power of the heaters is 6 kW. The connection should be made through N L1 N L1 a contactor. Additionally, you should choose appropriate differential and overcurrent protections for the heaters used. You can connect 2 electric heaters to the device, and they can be operated in 3 stages

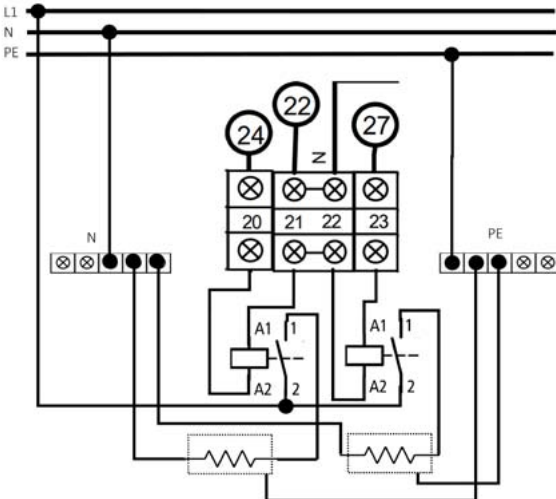

1. Heater 1 - ON, Heater 2 - OFF;
2. Heater 1 - OFF, Heater 2 - ON;
3. Heater 1 - ON, Heater 2 - ON.

Terminals 20, 21, 22, and 23 are responsible for the connection. After connecting the heaters, you should configure parameters H18 and R35. When the heaters are turned on (depending on the operating stage), the device will provide a voltage of ~230V at terminals 20 and 23. An example connection (single-phase heaters) is shown in the diagram below.

In the case where the heat pump operates exclusively in Domestic Hot Water mode, you can install the heater in the Domestic Hot Water tank and connect it to terminals 24 and 25 in a manner analogous to the diagram shown above.

4.5. Preparing the system for initial startup

The initial startup of a heat pump system requires the expertise of a qualified specialist with the necessary qualifications and authorization as a Service Partner granted by the manufacturer. This is a condition for receiving a warranty on the device. Before the system's first activation, it must be filled with appropriately treated heating water (in accordance with recommendations), and the system must be properly vented. The device should be prepared for startup without any additional actions.

Before turning on the device, make sure that:







1. Prior to starting work, disconnect the heat pump from the power source using a circuit breaker.
2. All water connections should be correctly installed and should not be leaking.
3. Ensure that all necessary valves in the heating system are open, allowing water to circulate freely.
4. The settings of the heat pump controller should be in accordance with the instructions and adjusted to the existing heating system.
5. The water system, including the buffer tank, must be full and well-vented.
6. Venting the heating system is crucial – make sure that all circuits are open, and the system is vented at the highest point. If necessary, add water, ensuring that a minimum pressure is maintained.
7. Carefully check the insulation and the correctness of electrical connections. It is essential that they are safe and well-protected from any contact with liquids during filling and system operation.





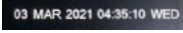

5. Controller manual

The installer should provide the user with information about the heat pump's operation and supply essential instructions for its safe use. Before using the device, it is advisable to carefully read the contents of this manual and the instructions for other devices used in the system, following the guidelines contained therein. This is crucial for ensuring the safe and effective operation of the heat pump system.

5.1. Description of the display interface





| Icon | Function |
|---|---|
|  | The power button: when the button is displayed in blue, it indicates the on state, and when touched, it will change color to white and switch to the off state. |
|  | Screen lock button: You can perform various operations on the display when the lock is open, but you cannot operate the display when the lock is closed. After locking the screen, press the screen lock button and enter the password "79" to unlock the screen. |
|  | It displays the current date, time, and day of the week. |
|  | Ambient temperature: Display the current ambient temperature. |
|  | "Turn on/off timer function" icon. This icon will be displayed when the timer function is enabled. |
|  | "Turn on mute timer function" icon. This icon will be displayed when the mute timer function is enabled. |
|  | "Enter defrost mode" icon. This icon will be displayed when the device enters defrost mode. |

| Icon | Function |
|---|--|
|  | "Fault" icon will be displayed in case of a device malfunction. |
|  | "Operating mode" icon means that the device is currently operating in heating + hot water mode. There are five available modes, namely: heating, cooling, hot water, hot water + cooling, hot water + heating. |
|  | The "Operating mode" icon indicates that the device is currently operating in heating mode. |
|  | The "Operating mode" icon indicates that the device is currently operating in cooling mode. |
|  | The "Operating mode" icon indicates that the device is currently operating in cooling mode + hot water mode. |
|  | The "Operating mode" icon indicates that the device is currently operating in hot water mode. |
| Mode | Mode selection button. When you touch the button, the device will enter the mode selection interface, allowing you to set the mode. |
| 55.0°C | The target temperature refers to the set temperature value corresponding to the current mode. |
| Target | The button for setting the target temperature. When you press this button, the device will enter the target temperature setting interface, allowing you to adjust the target temperature in the current mode. |
| 56.0°C | The water temperature at the outlet, which refers to the current water temperature at the outlet of the device. |
| DHW 32.0°C | Tank temperature, which refers to the current temperature of the water in the hot water tank. |
|  | Main interface icon, indicating that the current page is the main interface. Swipe left to enter the "Function Settings Interface"; Swipe right to go to the "Main Status Interface." |

5.2. Mode selection interface

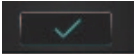

| Icon | Function |
|---|---|
| DHW + Heating | Mode selection element that will be highlighted when selected, indicating that the currently set mode is heating + hot water mode. |
| Heating | Mode selection position that will be highlighted when selected, indicating that the currently set mode is heating mode. |
| Cooling | Mode selection position that will be highlighted when selected, indicating that the currently set mode is cooling mode. |
| DHW + Cooling | Mode selection position that will be highlighted when selected, indicating that the currently set mode is cooling + hot water mode. |
| DHW | Mode selection position that will be highlighted when selected, indicating that the currently set mode is hot water mode. |
|  | Confirmation button that can be pressed to save the selected content. |
|  | Return button that can be pressed to go back to the main interface without saving the selected content. |



Mode selection:

Touch the "Mode Selection Button" on the main interface to enter the "Mode Selection Interface," then slide the "Mode Selection Element" to highlight the desired mode. Press the "Confirm" button to save and confirm the mode selection, which completes the mode selection operation. If you press the "Return" button, the system will return to the main interface without saving the settings.

5.3. Function Settings Interface

In the main interface, swipe to the left to access the "Function Settings Interface."

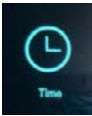

| Icon | Function |
|---|---|
|  | Time Type Function Button: Tap to enter the "Time Type Function Settings Interface" where you can set the system time, set the timer on/off, and configure the timer mute function (H22=1). |
|  | Function Settings Button: You need to enter a password to access the relevant function settings interface. |
|  | Curve Function Button: Allows you to record temperature changes from the last hours of operation. |

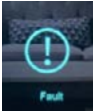
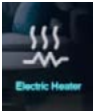
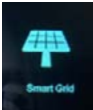





| Icon | Function |
|--|---|
|  <p>Brightness</p> | System Brightness Button: Allows you to adjust the brightness of the display. |
|  <p>Fault</p> | Error Display Function Button: Allows you to view error information. |
|  <p>Electric Heater</p> | One-Touch Rapid Heating Function Button: The icon is displayed only when $R35 \neq 0$. |
|  <p>Smart Grid</p> | Programmer of the Smart Grid mode, temperature, and power. |

5.4. Customer function interface.



Click  , "Password input interface" will appear, then enter the password "79" and press "Confirmation button" to enter the "Customer function interface".

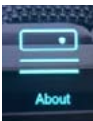



| Icon | Function |
|---|---|
|  | <p>Customer parameter button. Tap to enter the “Customer parameter interface,” which displays parameters that can be configured.</p> |
|  | <p>Manual defrost button. Tap to enter the manual defrost function.</p> |
|  | <p>The button for setting the outdoor temperature compensation curve. Tap to enter the outdoor weather curve setting interface.</p> |
|  | <p>The unit status button. Tap to enter the “Device status interface,” where the operating states (on/off) of individual installation elements are displayed.</p> |
|  | <p>The unit information button. Tap to enter the “Unit information interface,” where you can view essential information about the device and software.</p> |
|  | <p>The return button. Tap to return to the “Function settings interface.”</p> |

5.5. The time function settings interface.

In the “Function settings interface,” tap on the “Time function settings button” to enter the “Time function settings interface.” Here, you can set the system time, configure the timer switch, and enable the timer mute function.

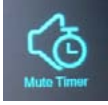

| Icon | Function |
|---|--|
|  | The "System time setting button" allows you to set the system time. |
|  | The "Mute timer button" allows you to enable time control for the mute function when the device has a mute function. |
|  | The "Timer on/off button" allows you to enable time control for turning the device on and off. |

5.6. Circulation of domestic hot water

When the circulation pump is connected and parameter H40 is set to 1 in the Time Function Settings Interface, an additional icon will appear for setting the operating time of the circulation pump:



5.7. Configuration of time functions

The Power Timer function, Mute Timer and Warm Water Cir. Control allow you to program the device's operating time as well as the circulation pump itself. The control panel allows you to set 6 time intervals and select the days of the week on which the functions should operate.



5.8. SG Ready



To access Smart Grid settings, you need to click on the icon  . The controller in the heat pump allows it to cooperate with a smart grid. The heat pump can be remotely started and stopped, even in partial load mode. Switching between different operating modes depends on factors such as access to energy from photovoltaic panels or the current energy tariff depending on the time of day. To use the Smart Grid function, you should use the contacts 1 and 2, as well as 7 and 8, as shown below, which allows you to define 4 operating modes.

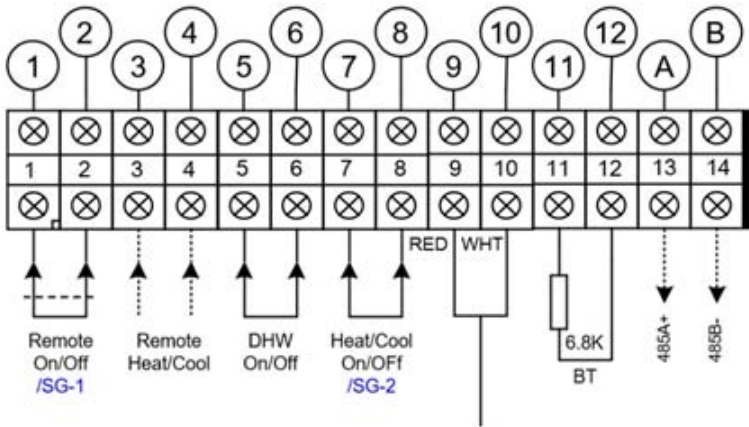

After entering the Smart Grid function, the screen will be displayed as follows:

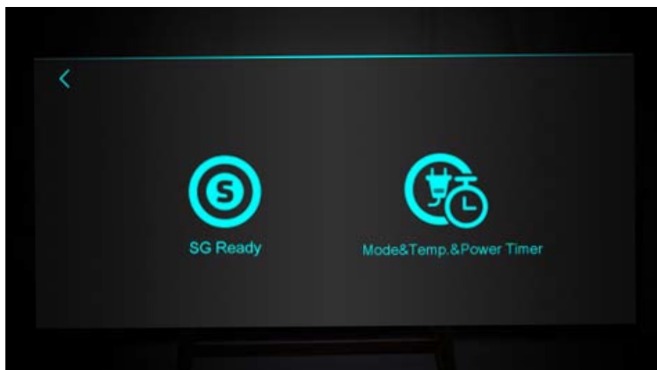

When using only one pair of contacts (7, 8) for the Smart Grid function, the pump can only operate in Mode 4.

Using a single potential-free contact:

| | |
|-------------|---------------------------|
| SG-2 | Smart Grid Ready=1 |
| Open | Normal mode |
| Closed | MODE-4 |

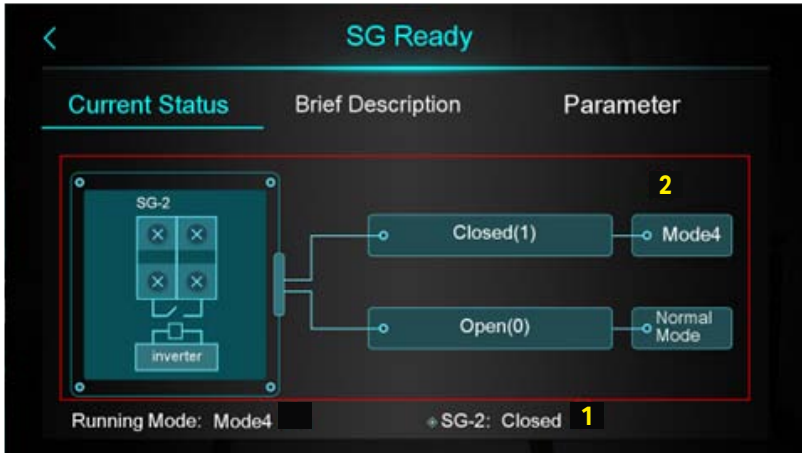

| | |
|---|--|
| 1 | Displays the current status |
| 2 | Illustration serving as an explanation |

Note:

SG-1 is the emergency switch port, and SG-2 is the PV connection port. In normal mode, enabling the electric heater is not allowed. Using both SG-1 and SG-2 ports, the pump can be controlled to operate in 4 modes.

Using two potential-free contacts:

| | | |
|-------------|-------------|---------------------------|
| SG-1 | SG-2 | Smart Grid Ready=2 |
| Closed | Open | MODE-1 |
| Open | Open | MODE-2 |
| Open | Closed | MODE-3 |
| Closed | Closed | MODE-4 |

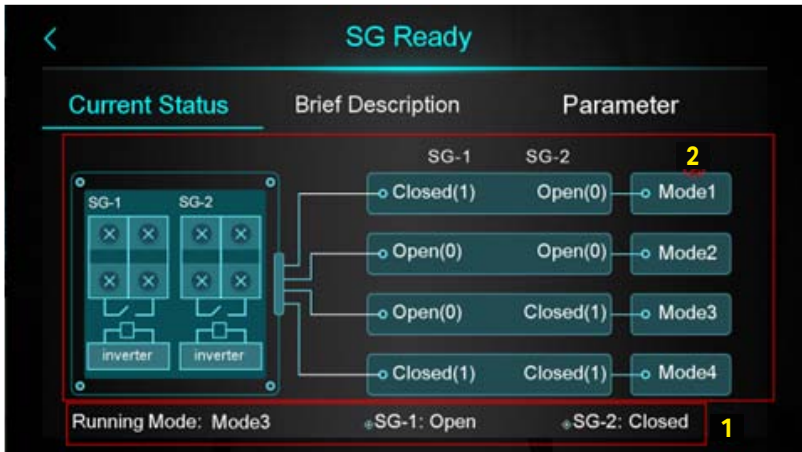

| | |
|---|--|
| 1 | Displays the current status |
| 2 | Illustration serving as an explanation |

MODE 1: Stand-by mode.

Available only when the heat pump is activated, in sleep mode, the heat pump is in standby mode (operating the same as when turned off after reaching the target temperature), the anti-freezing protection function can still be applied during this time. It's a sleep cycle that starts by entering sleep mode and waiting in standby mode.

Each time the device reaches the target temperature and turns off, it will have the opportunity to enter MODE 1. The chance is limited to 1 time. (The device can enter the sleep cycle only once, regardless of the number of stops after reaching the target water temperature). Therefore, there is only one chance to enter sleep mode, usually after the water temperature drops and restarts. If the device takes the opportunity and enters the sleep cycle, it will continue to operate until the next shutdown and the opportunity to enter MODE 1 again.

When the device is in standby mode, if MODE 1 is active, the heat pump will not enter MODE 1 or use the time of MODE 1. If the heat pump can maintain this state from standby mode to startup, the device will immediately enter MODE 1, taking the opportunity to enter MODE 1.

If the heat pump enters MODE 1 for a specified time (the time is regulated by parameter [SG02], default 120 minutes, maximum 120 minutes), forced exit from MODE 1 will occur, switching to normal mode, and operation will continue in the set mode (heating, DHW, etc.) until the device is automatically turned off.

When the heat pump enters sleep mode, anti-freezing protection is still effective to prevent freezing of pipes and equipment due to low outside temperature. This means that when the device is in sleep mode, if the outside temperature and the temperature of the pipe installation are lower than the winter anti-freeze protection operation condition, the heat pump will turn on and work with high energy efficiency to generate heat. After heating the water temperature in the pipes to a safe temperature to prevent freezing, the heat pump will exit the winter anti-freeze protection mode and continue to operate in sleep mode until the [SG02] condition is met or exiting MODE 1.

Conditions for exiting MODE 1:

Manual ON/OFF in MODE 1:

Manual OFF in MODE 1 – the heat pump will exit MODE 1 and switch to OFF.

If the pump is manually turned on again, the system will first check if the device is in MODE 1, then determine if it needs to enter MODE 1 – it will go directly to MODE 1 instead of turning on the device.

2. MODE-2: Low sunlight mode

Available only after the heat pump is activated. When the heat pump enters low sunlight mode, the settings for this mode will appear on the main screen.

1. Target working temperature = temperature setting;
2. Do not turn on the electric heater in this mode.
3. The heat pump's performance is determined by parameter [SG03].

3. MODE-3: Medium sunlight mode

Available only after the heat pump is activated. When the heat pump enters medium sunlight mode, the settings for this mode will appear on the main screen.

4. Target working temperature = temperature setting;
5. Do not turn on the electric heater in this mode.
6. The heat pump's performance is determined by parameter [SG04].

4. MODE-4: High sunlight mode

Available only after the heat pump is activated. When the heat pump enters high sunlight mode, the settings for this mode will appear on the main screen.

- 1 – In heating mode: Target working temperature = temperature setting + parameter [SG06]
2. – In cooling mode: Target working temperature = temperature setting + parameter [SG07]
3. – In domestic hot water (DHW) preparation mode: Target working temperature = temperature setting + parameter [SG05]

Note:

In the case of no demand for domestic hot water (DHW), the heat pump will automatically raise the hot water temperature setpoint to ensure automatic switching to DHW mode using the heat stored in the DHW tank.

In MODE 4, the activation of the electric heater can be set using a parameter.

If the electric heater is active in MODE 4, it will be turned on immediately to convert electrical energy into heat as quickly as possible during the most intense sunlight.

Note:

Taking into account the safe operating range, in this mode, the heat pump is limited by the maximum water temperature curve.

Note:

1 – Temperature Compensation in MODE 4:

There are four options for controlling the automatic start/stop of the heat pump:

H25=3 [Buffer tank temperature];

H25=2 [Inlet water temperature];

H25=0 [Outlet water temperature];

H25=1 [Room temperature];

If H25=1, temperature compensation in high sunlight mode only works for the outlet water temperature.

If H25=3/2/0, temperature compensation in high sunlight mode works for the temperature set by parameter H25.

If multi-zone control function is enabled and H25≠1, temperature compensation in high sunlight mode works for the temperature set by parameter H25.

2 – Time Delay Between Mode Switching:

If there is a need to switch modes, the heat pump must operate in the current mode for at least 10 minutes before switching to another mode.

The information about the modes on the display:



The parameters related to the Smart Grid function are described below:

| Code | Parameter | Settings |
|------|---|--|
| SG01 | SG Ready application | 0 - inactive 1 - one potential-free contact 2 - two potential-free contact |
| SG02 | Mode 1 lockout time | 0-120 min |
| SG03 | Power limitation in low sun mode Mode 2 | 0-99,9 kW |
| SG04 | Power limitation in medium solar mode Mode 3 | 0-99,9 kW |
| SG05 | Additional hot water temperature in Mode 4 | 0-25°C |
| SG06 | Additional heating temperature in Mode 4 | 0-25°C |
| SG07 | Additional cooling temperature in Mode 4 | 0-25°C |
| SG08 | Immediate activation of the electric heater in Mode 4 | 0-No/1-Yes |

To set SG Ready parameters:

- Go to the "Smart Grid" tab, then the "SG Ready" icon and then "Parameters"

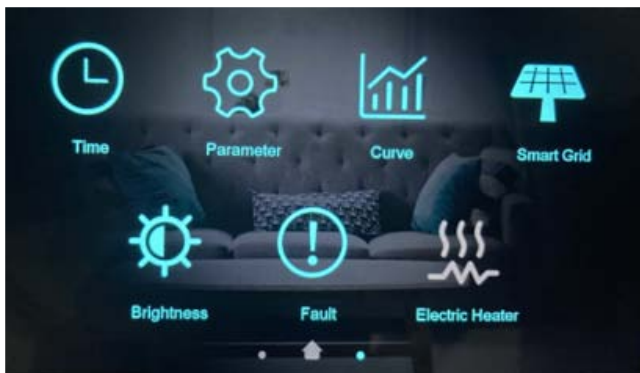

- Input password: 79

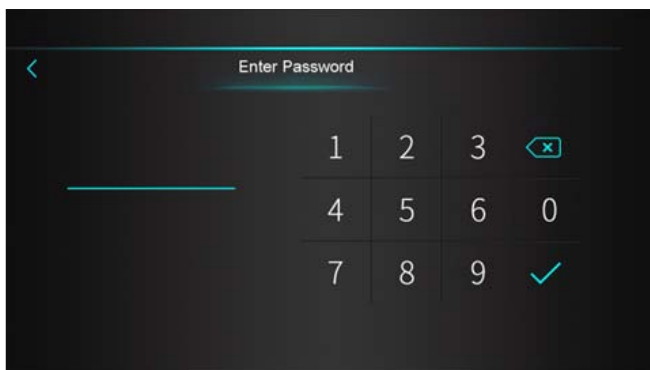

- The parameter configuration screen is displayed



5.8.1. Programmer for Mode, Temperature, and Power



After clicking the icon mentioned above, the screen displayed will be as follows:

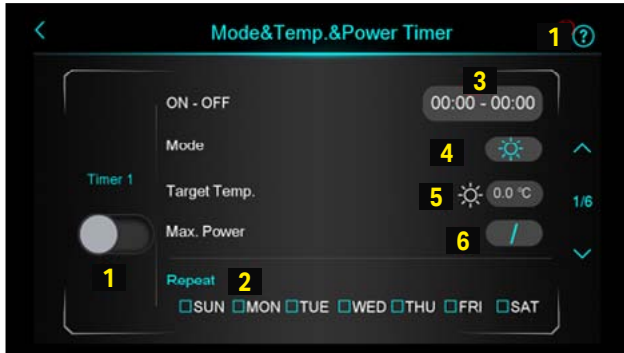

| | |
|---|--|
| 1 | Turning on the programmer. |
| 2 | Set the time interval |
| 3 | Set the days of the week. |
| 4 | Set the desired mode of operation. If you do not want to control the mode, set the "disabled" option. |
| 5 | Set the desired temperature |
| 6 | Set the power limitation If power limitation is not necessary, set "Max. Power" to 0. |
| 7 | Press to display information about the function. |

The software allows you to view the description of mode, temperature and power functions:

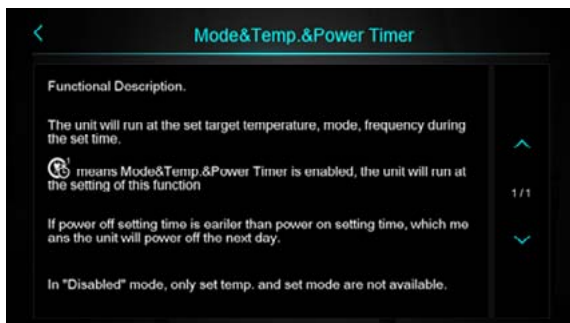

The function allows you to set the operating time, operating mode (heating, cooling, hot water domestic hot water), the set temperature in a given mode and power limitation. You can select on which days of the week the set parameters are to apply.

After activating the function, the start screen will display the icon .

5.9. Multi-zone control

When there are 2 zones in the installation, it is possible to control 2 zones with the heat pump:

- Disabling Zone Control:

If parameter Z01=None(0), the zone control function is inactive. During this time, the zone control function will not be visible.

- Enabling Zone Control:

If parameter Z01 ≠ 0, the zone control function is active.

You can click the "Set Temp."  option to access the target temperature configuration interface.

- Multizone Control Interface:

Click the "" icon to access the multizone control function interface.

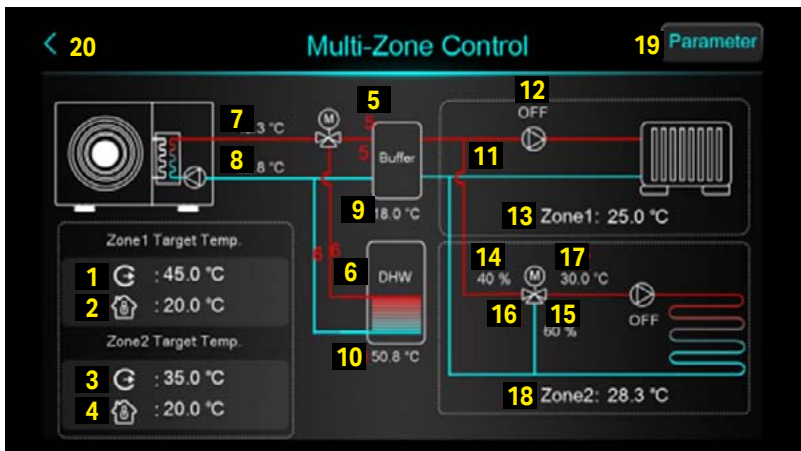

| | |
|----|---|
| 1 | If Z16=0 (temperature curve for zone 1 is inactive), the temperature displayed will be Z06 (target temperature at the outlet in zone 1). If Z16=1 (temperature curve for zone 1 is active), the displayed temperature will be after compensation, which is the target temperature at the outlet. |
| 2 | Z02 - Target room temperature in zone 1. |
| 3 | If Z17=0 (temperature curve for zone 2 is inactive), the displayed temperature will be Z07 (target temperature at the outlet in zone 2). If Z17=1 (temperature curve for zone 2 is active), the displayed temperature will be the target temperature at the outlet after compensation). |
| 4 | Z03 – Target room temperature in zone 2. |
| 5 | This line will appear during heating mode operation. |
| 6 | This line will appear during domestic hot water mode and during high-temperature disinfection. |
| 7 | Display of outlet water temperature T02. In case of sensor failure, it will display -- °C/°F. |
| 8 | Display of inlet water temperature T01. In case of sensor failure, it will display -- °C/°F. |
| 9 | If H25=Buffer tank control, it will display the temperature in the buffer tank T07. In case of sensor failure, it will display -- °C/°F. If H25≠Buffer tank control, it will display -- °C/°F. The status of the buffer tank will change to "Not used." |
| 10 | The display of the temperature in the tank T08 It will show -- °C/°F in case of sensor failure. |
| 11 | This group of lines will appear when zone 1 pump is activated. |
| 12 | When zone 1 pump is turned on, the ON indicator will be displayed; otherwise, it will show OFF. |
| 13 | Presentation of room temperature for zone 1. In case of a sensor malfunction, it will display -- °C/°F. If Z01=4/5/6/7/8/9, the device is connected to a passive thermostat or room thermostat, and the device receives a signal. If a command to turn on the device is sent from the thermostat, it will display Zone1: Start; otherwise, it will show Zone 1: Stop. |
| 14 | It displays the percentage value of the opening degree of the mixing valve in zone 2. |
| 15 | It displays the percentage value of the opening degree of the mixing valve in zone 2. The sum of the percentages from point 14 and point 15 equals 100%. |
| 16 | This group of lines will appear when the zone 2 pump is turned on. |
| 17 | Display of water mixing temperature for zone 2. In case of sensor malfunction, it will display -- °C/°F. |

| | |
|----|--|
| 18 | Display of room temperature for zone 2. In case of sensor malfunction, it will display -- °C/°F. If Z01=4/5/6/7/8/9, the device is connected to a passive room thermostat or room thermostat, and the device receives a signal. If a command to turn on the device is sent from the thermostat, Zone2: Start will be displayed, otherwise, it will display Zone 2: Stop. |
| 19 | After clicking, enter password 22 and go to the list of parameters for zone control function. |
| 20 | Click to return to the previous screen. |

5.9.1. Multizone control parameters

- Click „Parameters”

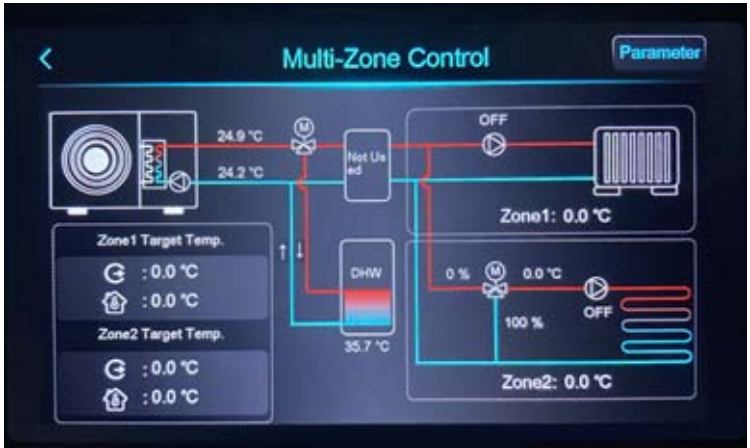

- Enter the password:79

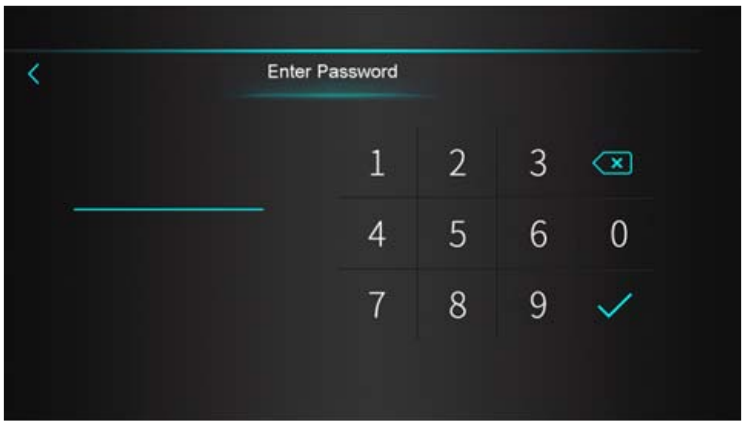

- The displayed parameters will include settings for controlling.



- List of parameters

Remarks on the designations:

S - temperature sensor

T - thermostat

P - passive thermostat

RT - room temperature

WT - water temperature

| Code | Parameter | Range |
|------|--------------------------------|---|
| Z01 | Enable Zone Control | 1. Zone 1-S 2. Zone 2-S 3. Zone 1&2-S 4. Zone 1-T 5. Zone 2-T 6. Zone 1&2-T 7. Zone 1-P 8. Zone 2-P 9. Zone 1&2-P |
| Z02 | Target RT for Zone 1 | 10-35 °C |
| Z03 | RT Difference for Zone 1 Start | 0-10 °C |

| Kod | Parametr | Zakres |
|------------|--|----------------------|
| Z04 | Target RT for Zone 2 | 10-35 °C |
| Z05 | RT Difference for Zone 2 Start | 0-10 °C |
| Z06 | Target WT at the Outlet for Zone 1: | R10-R11 °C |
| Z07 | Target WT at the Outlet for Zone 2: | R10-Z15 °C |
| Z08 | Manual Regulation Coefficient of the Mixing Valve (0% for automatic control): 0-100% | 0-100% |
| Z09 | Mixing Valve Opening Time | 0-2000 s |
| Z10 | Mixing Valve Closing Time | 0-2000 s |
| Z11 | Mixing Valve P Control (PID) | 0-10.0 |
| Z12 | Mixing Valve I Control (PID) | 0-10.0 |
| Z13 | Duration of PID Control for the Mixing Valve: | 1-20 min 1-20 min |
| Z14 | Degrees of the Mixing Valve in Cooling Mode | 0-100% |
| Z15 | Maximum Target Water Temperature for Zone 2 | 0-99 °C |
| Z16 | Activate Temperature Compensation (AT) for Zone 1: | 0-NO 1-YES |
| Z17 | Activate Temperature Compensation (AT) for Zone 2: | 0-NO 1-YES |
| Z19 | Temperature Difference at Low Water Temperature without Pump Operation | 0 °C ~25 °C |
| Z20 | Activate Water Pump for Zone 1 in Cooling Mode | 0-NO 1-YES |

5.9.2. Zones controll options

- No zones 1 and 2

After setting Z01=0 in the list of zone control parameters on the interface of this function, the screen displayed will be as follows:

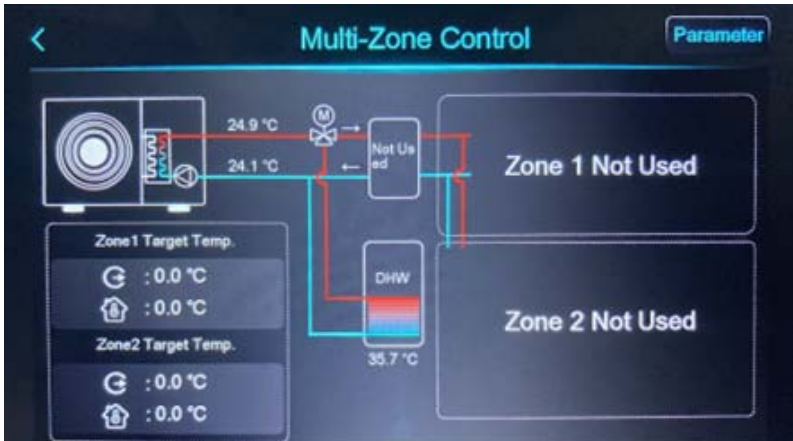

- Activation of zone 1

Setting Z01=1/4/7 means that zone 2 is inactive. Only zone 1 is active. The status of zone 2 will be displayed as "Not used."

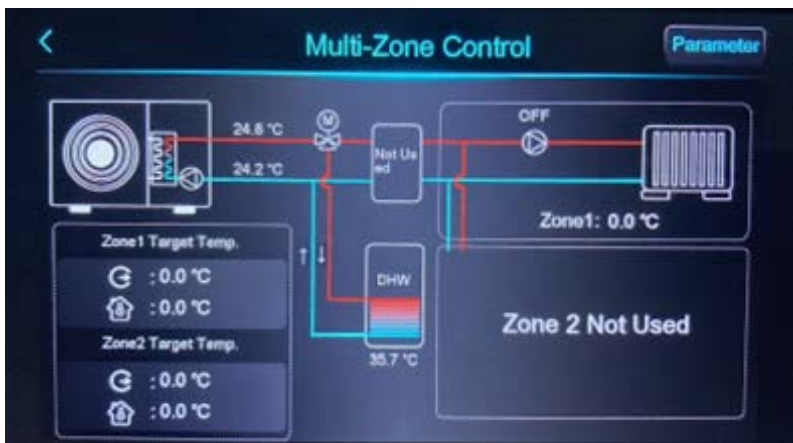

- Activation of zone 2

Setting Z01=3/6/9 means that both zone 1 and 2 are active. Below is a screen showing both zones being active.

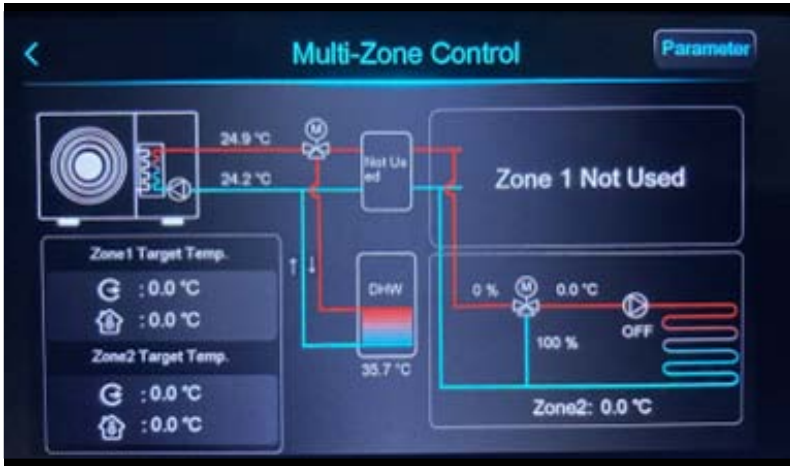

- Activation of zones 1 and 2

Setting Z01=3/6/9 means that both zone 1 and 2 are active. Below is a screen showing both zones being active.

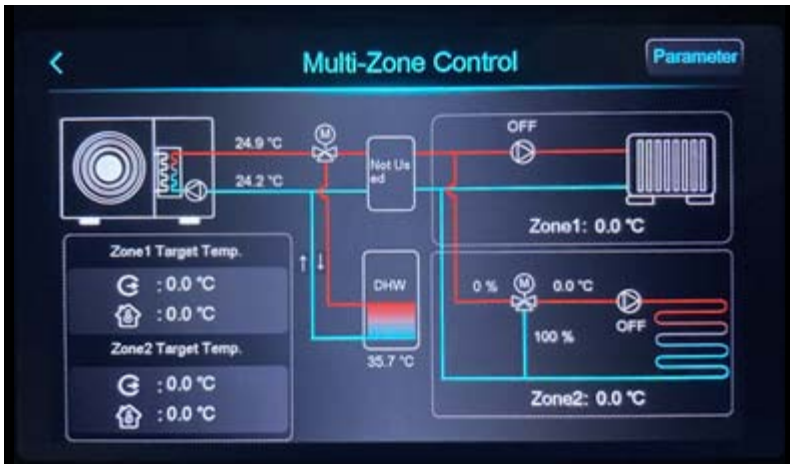

5.9.3. Desired temperatures for zones settings



After clicking on Set Temp. depending on the zone, a screen for setting temperatures according to the applied solution (water, room, or heating curve) will appear:



Click on the 'Zone 1 Weather Control' option to access the temperature curve settings for Zone 1.

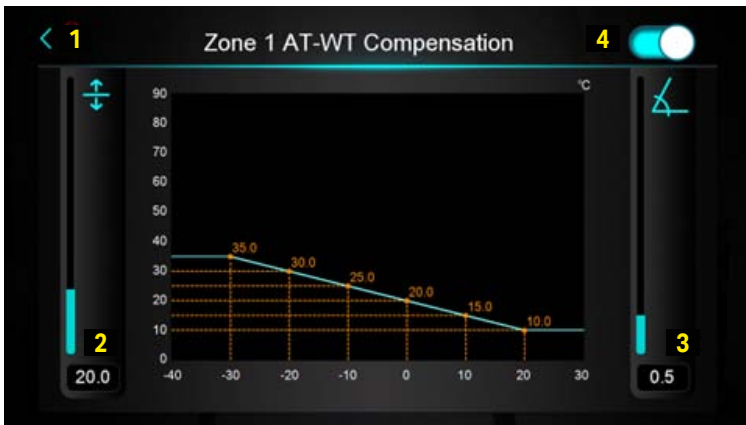

| | |
|---|---|
| 1 | Click to return to the previous interface. |
| 2 | The target temperature at an outside temperature of 0°C (0~85). |
| 3 | Slope of the temperature curve (0~3.5). |
| 4 | Temperature compensation activation button. |

5.10. Mute mode

The "Mute" function affects the operation of the device by reducing the power of the heat pump (fan speed) and providing quieter operation. You can specify the time to activate and deactivate the function, as well as move the buttons below the set times to enable/disable the function. It's important to note that activating mute mode may result in increased use of additional electric heating when the reduced power of the heat pump is not sufficient to provide adequate heating to the building.

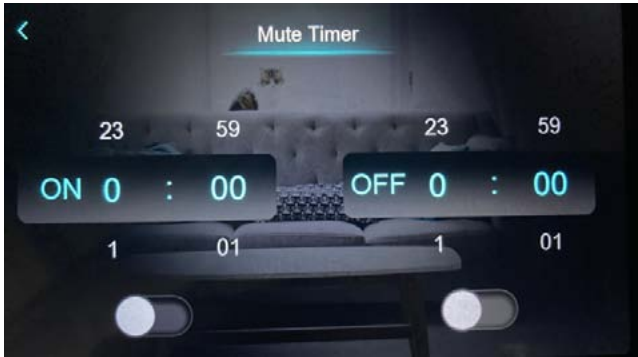

5.11. Curve

The temperature curve function records water temperature at the inlet and outlet. Temperature data is collected every five minutes, and 12 sets of temperature data are saved every hour. The timing is based on the last recorded data. If there is a power interruption lasting less than 1 hour, data for that period will not be saved.

Only the on-state curve is saved when the device is turned on, and the off-state curve is not saved. The value cut-off indicates the time from a point on the curve to the current time. The rightmost point on the first page is the most recent temperature recording. Curve temperature recording is made possible by a memory function that operates even when the power is off.

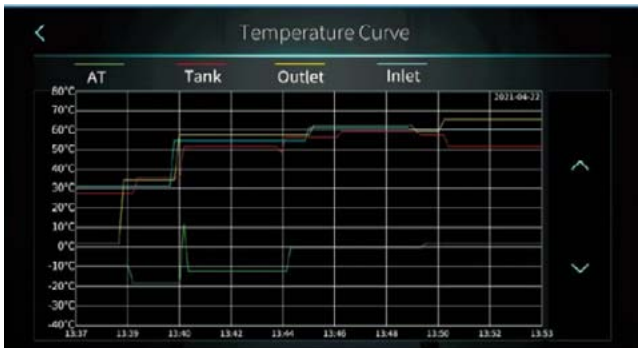

5.12. Failure/Faults

Clicking on the 'Fault' icon will open a list of error history as shown below. Servicing the device can only be performed by a qualified and authorized technician. Service procedures are detailed in the 'Service' section.



6. Parameters

At the first start-up of the heat pump, you should check and configure some operating parameters of the device depending on the entire installation and the components used. To do this, from the 'Customer Function Interface,' go to 'Parameters.' In the case of device servicing, you can use an extensive list of service parameters. To access the service setting codes, enter the service code (access to the document is exclusive to the Service Partner). The tables below show the service parameters for the KHY heat pump. Parameters marked in red are factory-set, and users/technicians are not authorized to change them (changing any of the parameters marked in red requires manufacturer approval). Parameters marked in green are the ones that should be configured during the first start-up. Parameters marked in orange are those whose change is not necessary during the first start-up.

6.1. System

| Code | Name | Description | Range |
|------|-------------------------|--|---------------|
| H01 | Enable Power-off Memory | It is used to set whether there is power-off memory for startup operation | 0-NO 1-YES |
| H05 | Enable Cooling Function | It is used to set whether the heat pump has a refrigeration function, when it is set to no refrigeration function, there is no refrigeration mode on the wire controller | 0-NO 1-YES |

| Code | Name | Description | Range |
|-------------|-------------------------|---|--|
| H07 | Control Mode | The startup and shutdown and mode used to configure the heat pump are controlled by the wire controller, or controlled by the emergency switch and mode switch | 0-Display 1-Dry Contact |
| H10 | Unit Address | When the heat pump is connected to an external controller through R485, the heat pump acts as a slave, and H10 is used to configure the slave address of the heat pump | 1~32 |
| H18 | Electric Heater Stage | Stage 1 and Stage 2 on the heat pump terminals are used for electric heating. In general, the electric heating power connected to Stage 2 is greater than that of Stage 1. You can set where the electric heating is used through R35, and you can choose several levels of electric heating through H18. | 1-Stage1 2-Stage2 3-Stage3 |
| H20 | 3-Way Valve Polarity | Control whether the three-way valve is energized in hot water mode or in heating mode. In general, it is related to the way the three-way valve is connected, and we recommend using the hot water mode to energize. | 0-Hot Water-ON 1-Hot Water-OFF |
| H21 | Temperature Unit | Set the display units of various parameters of the wire controller | 0-°C 1-°F |
| H22 | Enable Silent Mode | Set whether there is a mute function on the wire controller | 0-NO 1-YES |
| H25 | Temp. Control Selection | Configure which water temperature is used as the target temperature for refrigeration/heating mode to regulate the compressor frequency | 0-Outlet Water Temp. 1-Room Temp. 2-Buffer Tank Temp. 3-Inlet Water Temp. |

| Code | Name | Description | Range |
|-------------|--|--|--|
| H27 | Enable EVI | It is used to control whether the heat pump has the function of vapor-injected enthalpy gain, which is related to the configuration of the heat pump itself | 0-No EVI 1-EVI for Cooling 2-EVI for Heating 3-All EVI |
| H28 | Heating/Cooling and Hot Water Function Enabled | It is used to set whether the heat pump has a hot water function, when it is set to no hot water function, there is no hot water mode on the wire controller | 0-NO 1-YES 2-Only DHW |
| H29 | Operation Code | Reserved parameters, reserved for the model selection of the driver board and compressor | 0~20 |
| H30 | Enable Hydraulic Module | When used with a matching hydraulic module, it needs to be configured as 1 | 0-NO 1-YES |
| H31 | Circulation Pump Type | It is used to enable the water pump flow display function | 0-No Flow Detection 1-Grundfos (25~75) 2-Grundfos (25~105) 3-Grundfos (25~125) 4-APM25-9-130 5-APF25-12-130 |
| H32 | Force Switch Mode Time | If the heat pump is set to the compound mode (refrigeration + hot water, heating + hot water), and the hot water mode cannot reach the constant temperature shutdown condition for a long time, the heat pump will be forced to switch to the heating or refrigeration mode after the longest running time of H32 in the hot water mode. | 1~300 |

| Code | Name | Description | Range |
|-------------|---|---|--|
| H33 | Fan Motor Driver and Comp. Driver Intergrated | It is used to match the fan driver module and needs to be set according to the actual configuration of the heat pump | 0-NO 1-YES |
| H36 | Enable Positive Weather Compensation | "Compensate set temp = Slope *AT + Offset After the ambient temperature compensation curve is enabled, the target temperature of the heat pump will be automatically regulated according to the ambient temperature, Compensate set temp = Slope *AT + Offset" | 0-NO 1-YES |
| H37 | DWH Temp. Sourcing | It is used to configure the source of the hot water tank temperature in the hot water mode of the heat pump, and usually used to match the external controller | 0-DHW Tank Sensor 1-External from Modbus |
| H38 | Language | It is used to configure the language displayed on the wire controller, only CP307 supports language switching function | 0-English 1-Polish 2-German 3-Dutch |
| H40 | External pump selection | Specifies the external pump connected to the main board of the device. 0 – water pump for the plate heat exchanger for domestic hot water production (instead of a coil in the DHW tank), 1 – DHW circulation pump. | 0-Hot Water Pump 1-Warm Water Cir. Pump 2-Off signal when defrosting |
| H41 | Password for Unmodified Parameters | Password for service parameters. | 66 |
| H42 | AT for Botton Plate Heater Turned On | Specifies the external temperature to activate the condensate tray heater. | -20~20°C |

6.2. Protect

| Code | Name | Description | Range |
|------|---|--|---------------|
| A03 | Shutdown Ambient Temp. | When the ambient temperature is lower than A03, the heat pump will turn off the compressor and use the auxiliary heat source to continue heating. | -40~10°C |
| A04 | Antifreeze Temp. | It is used to prevent the water temperature from being too low to damage the replacement plate by freezing. When the water outlet temperature is < A04 and the anti-freezing temperature is < A04-A05, the heat pump will report anti-freezing protection. | A22~10°C |
| A05 | Antifreeze Temp. Difference | It is used to prevent the water temperature from being too low to damage the replacement plate by freezing. When the water outlet temperature is < A04 and the anti-freezing temperature is < A04-A05, the heat pump will report anti-freezing protection. | 1~50°C |
| A06 | Max. Exhaust Temp. | It is used to prevent the compressor from overheating and control the discharge temperature within a safe range | 60~130°C |
| A11 | Enable Low Pressure Sensor | According to the configuration of the heat pump itself, set whether there is a pressure sensor | 0-NO 1-YES |
| A21 | Ambient/Suction/Coil Sensor Type | Configure the corresponding detection plan according to the sensors mounted on the heat pump itself | 0-5K 1-2K |
| A22 | Min. Antifreeze Temp. | A04 > A22 | -20~10°C |
| A23 | Min. Outlet Water Temp. Protect | It is used for anti-freezing in refrigeration and defrosting modes. When the water outlet temperature is close to A23, the heat pump will reduce the frequency in advance to prevent damaging the replacement plate by freezing. When the water outlet temperature is < A23, the heat pump will shut down for protection. | -30~20°C |
| A24 | Excess Temp. Diff. Between Inlet and Outlet Temp. | It is used for anti-freezing in refrigeration and defrosting modes. When the temperature difference between water inlet and outlet is close to A24, the frequency will be reduced in advance. When the temperature difference between water inlet and outlet is > A24, it will shut down for protection. Please keep the refrigeration flow up to the rated flow to avoid insufficient heating capacity due to unclean defrosting. | 0~30°C |

| Code | Name | Description | Range |
|-------------|--|---|---------------|
| A25 | Minimum Evaporation Temp. of Cooling | It is used to prevent the water temperature from being too low to damage the replacement plate by freezing. When the water outlet temperature is < A04 and the evaporation temperature is < A25, the heat pump will report anti-freezing protection. | -50~30°C |
| A26 | Refrigerant Type | It is used to select the refrigerant type | R290 |
| A27 | Temp. Diff. Of Limiting Frequency | The parameter A27 & A28 can limit the capacity of heatpump in DHW mode, it will keep a stable difference (can be set by A28) between outlet and water tank temperature to keep a stable heating speed ,this fuction will be actived when the outlet reach at (R62 - A27) degrees Celsius | -20~95°C |
| A28 | Temp. Diff. Between Outlet and DHW Temp. | | -20~95°C |
| A29 | Enable High Pressure Sensor | Configure the corresponding detection plan according to the sensors mounted on the heat pump itself | 0-NO 1-YES |
| A30 | Min. AT for Cooling | The compressor of the heat pump has high-pressure and low-pressure ranges for safe running. Configure this parameter according to the safe running range of the compressor. Running the refrigeration mode below the allowable running temperature range of the compressor will greatly reduce the life of the compressor | -30~60°C |
| A31 | Electric Heater On AT | Specifies the maximum external temperature at which the electric heater can operate. | -30~60°C |
| A32 | Electric Heater Delays Comp. On Time | Specifies the time delay after which the compressor will start following the activation of the electric heater. | 10~999min |
| A33 | Electric Heater Opening Temp. Diff. | Specifies the temperature hysteresis at which the electric heater can turn on. | 0~20°C |
| A34 | Crank Preheating Time | Crankcase heating time | 0~360min |
| A35 | Electric Heater Off Temp. Diff. | Specifies the temperature hysteresis at which the electric heater will be turned off. | 0~30°C |

| Code | Name | Description | Range |
|-------------|---|---|-------------------------|
| A38 | Low Pressure of Limiting Frequency | Pressure at which the compressor frequency will be limited. | 0~20bar |
| A39 | Max. Current Value | Specifies the maximum current value drawn by the device. | 0~50A |
| A40 | Rated Water Flow | Specifies the water flow. | 0-9,99m ³ /h |
| A41 | Circulation Pump Speed Regulation of target Temp. Diff. | Temperature difference of water. | 0~20°C |

6.3. Fan

| Code | Name | Description | Range |
|-------------|--|---|-----------------------------------|
| F01 | Fan Motor Type | Choose according to the actual fan configuration of the heat pump | 3-DC 4-DC with External Driver |
| F02 | Coil Temp. for Max. Fan Speed in Cooling | In refrigeration mode, if the coil temperature is higher than F02, the fan must be regulated to the highest speed of F25 to increase the amount of heat exchange on the condensing side | -15~60°C |
| F03 | Coil Temp. for Min. Fan Speed in Cooling | In refrigeration mode, if the coil temperature is lower than F03, the fan must be regulated to the lowest speed of F18 to decrease the amount of heat exchange on the condensing side | -15~60°C |
| F05 | Coil Temp. for Max. Fan Speed in Heating | In heating mode, if the coil temperature is lower than F05, the fan must be regulated to the highest speed of F26 to increase the amount of heat exchange on the evaporation side | -15~60°C |
| F06 | Coil Temp. for Min. Fan Speed in Heating | In heating mode, if the coil temperature is higher than F06, the fan must be regulated to the lowest speed of F19 to decrease the amount of heat exchange on the evaporation side | -15~60°C |
| F10 | Fan Quantity | Choose according to the actual fan configuration of the heat pump | 0-NO 1-YES |
| F18 | Min. Fan Speed in Cooling | Minimum fan speed during cooling. | 10~1300r |

| Code | Name | Description | Range |
|-------------|---|---|---------------|
| F19 | Min. Fan Speed in Heating | Minimum fan speed during heating. | 10~1300r |
| F22 | Enable Manual-Control Fan Speed | It is used for engineer performance debugging experiments, when F22=1, the fan speed will be fixed at F23 | 0-NO 1-YES |
| F23 | Rated DC Fan Motor Speed | It is used for engineer performance debugging experiments, when F22=1, the fan speed will be fixed at F23 | 10~1300r |
| F25 | Max. Fan Speed in Cooling | Maximum fan speed during cooling. | 10~1300r |
| F26 | Max. Fan Speed in Heating | Maximum fan speed during heating. | 10~1300r |
| F27 | Fan Motor Power Curve | Reserved parameters, no related function is available. | 0~100 |
| F28 | CT to Reduce Two Fans to One in Cooling | In cooling mode, if the heat exchanger temperature is lower than F28, one fan will be unloaded to reduce the amount of heat exchanged for condensing purposes. | -30~60°C |
| F29 | CT to Stop Single Fan in Cooling | In cooling mode, if the heat exchanger temperature is lower than F29, all fans will be turned off to reduce the amount of heat exchanged for condensing purposes. | -30~60°C |

6.4. Defrost

| Code | Name | Description | Range |
|-------------|--|--|--------------|
| D01 | Ambient Temp. of Starting Defrosting | If the external temperature is higher than the set value, the heat pump will not enter the defrost mode. | -37~45°C |
| D02 | Heating Operation Time Before Defrosting | If the accumulated heating time does not reach D02, the heat pump will not enter defrosting | 0~120min |
| D03 | Interval Time Between Defrosting Cycles | Start counting from the latest completion time, if the cumulative time does not reach D03 (or D03 after correction), it is not allowed to enter defrosting | 30~90min |

| Code | Name | Description | Range |
|-------------|---|---|--------------|
| D04 | Exhaust Temp. Correction for Defrosting Cycle | Correct the defrosting D03 through the refrigerant circulation state of the fluorine system | 0~150°C |
| D05-1 | Defrosting Suction Pressure 1 | | 0~45bar |
| D05-2 | Defrosting Suction Pressure 2 | | 0~45bar |
| D06 | Defrosting Cycle Time Correction | The defrosting D03 is corrected through the refrigerant circulation state of the fluorine system, and the defrosting interval after the correction will become D03-D06 | 0~120min |
| D07 | Ambient Temp. of Start Sliding Defrosting | The heat pump judges whether to perform defrosting based on the correlation between the back temperature and the refrigerant circulation volume. The reference back temperature is not fixed. When the ambient temperature is greater than D07, the reference back temperature is D08; once the ambient temperature is lower than D07, the reference point will decrease as the ambient temperature decreases. When the ambient temperature drops below D09, the reference point will not continue to drop, and the corresponding lowest reference point at this time is D10. | -37~45°C |
| D08 | Suction Temp. of Start Sliding Defrosting | | -37~45°C |
| D09 | Ambient Temp. of Stop Sliding Defrosting | | -37~45°C |
| D10 | Suction Temp. of Stop Sliding Defrosting | | -37~45°C |
| D11 | Min. Inlet Water Temp. of Defrosting | Due to the small flow and slow flow rate of each branch of the internal structure of the plate-type heat pump, it is easier to freeze than the high-efficiency tank. In order to avoid this risk, it is necessary to ensure that the water temperature is > D11 before entering defrosting, so as not to damage the replacement plate by freezing. | 4~65°C |
| D12 | Suction Pressure of Forced Defrosting | According to the corresponding relationship between the low pressure and the refrigerant circulation volume of the fluorine system, when the low pressure is lower than D12 and the system meets other conditions, it is predicted that the system is in a state of severe frosting, and at this time, forced defrosting will be performed. | 0~45bar |

| Code | Name | Description | Range |
|-------------|--|--|--------------|
| D13 | Heating Operation Time Before Forced Defrosting | According to the corresponding relationship between the low pressure and the refrigerant circulation volume of the fluorine system, as well as the ambient temperature, if the time in the buffer zone that may have frost and may not have frost is too long, and the time exceeds D13, a defrosting will be forced | 0~360min |
| D14 | Fan Motor Power Ratio to Extend Defrosting Cycle | Products that can accurately calculate fan power have related functions. If the coefficient of variation of fan power is less than D14 within a certain period of time, the defrosting interval will be extended to D23. | 0.00~5.00 |
| D15 | Fan Motor Power Ratio to Enter Forced Defrosting | Products that can accurately calculate fan power have related functions. If the coefficient of variation of fan power is greater than D15 within a certain period of time, defrosting will be forced. | 0.00~5.00 |
| D16 | Max. Fan Motor Power to Enter Forced Defrosting | Products that can accurately calculate fan power have related functions. If the fan power is D16 within a certain period of time, defrosting will be forced. | 50~1000W |
| D17 | Coil Temp. of Exit Defrosting | If the coil temperature rises above D17 during defrosting, it means that defrosting has basically been completed, and shall be exited | -37~45°C |
| D18 | Distributor Tube Temp. of Exit Defrosting | If the temperature at the distributor rises above D18 during defrosting, it means that defrosting has essentially ended, and it will be turned off. | -37~80°C |
| D19 | Max. Defrosting Time | The maximum time allowed for defrosting. If the defrosting conditions are still not met after D19, defrosting will be forced to exit. | 0~20min |

| Code | Name | Description | Range |
|-------------|---|---|--|
| D20 | Defrosting Frequency | Standard frequency of the compressor during defrosting. If it is detected that the temperature difference between the water inlet and outlet is close to A24, or the water flow is less than D22, the frequency will be reduced to 50Hz for defrosting. | 30~90Hz |
| D21 | Enable Electric Heater During Defrosting | When the water temperature is too low and the defrosting capacity is insufficient, when there is electric heating on the waterway, it can be supplemented by starting the electric heating during defrosting. | 0-NO 1-YES |
| D22 | Water Flow of Defrosting | If the water flow is less than D22 during defrosting, the frequency will be reduced to 50Hz for defrosting | 0~50m ³ /h |
| D23 | Max. Defrosting Cycle by Fan Motor Power | Products that can accurately calculate fan power have related functions. If the coefficient of variation of fan power is less than D14 within a certain period of time, the defrosting interval will be extended to D23. | 0~240min |
| D24 | Defrosting Heating Source in Heating / DHW Mode | It is used to set whether to obtain heat from the hot water side or the heating side for defrosting. During defrosting, the water temperature on the heat source side will decrease. | 0-Stay Current Circuit 1-DHW Circuit 2-Heating Circuit |
| D25 | Max. Water Temp. Decrease during Defrosting | After entering defrosting, if the water inlet temperature decreases by D25°C, defrosting will be exited. It is used to protect the replacement plate from freezing when the water inlet temperature is low. | 2~65°C |

| Code | Name | Description | Range |
|-------------|--|---|---------------|
| D26 | Enable Defrosting Communication in Cascade | When the heat pump is linked with the external controller, the external controller can decide whether to allow the heat pump to enter defrosting. When the heat pump initiates a defrosting request, but the external controller does not allow the heat pump to defrost, the heat pump can wait up to 8min before entering defrosting. | 0-NO 1-YES |

6.5. EEV

| Code | Name | Description | Range |
|-------------|-------------------------------|---|-------------------------------|
| E01 | EEV Adjust Mode | Configuration of the electronic expansion valve control mode, which should be set to 1 - automatic. | 0-Manual 1-Auto 2-Smart |
| E02 | Target Superheat for Heating | Control of evaporation and condensation in the refrigeration system to achieve balance, ensuring optimal heat exchange. | -20~20°C |
| E03 | EEV Initial Steps for Heating | The throttling device on the main circuit of the fluorine system is at the initial opening of the heating mode, and it is in this position for a period of time when the fluorine system is just started | 0~500N |
| E07 | EEV Min. Steps | Minimum opening of the throttling device on the main circuit of the fluorine system | 0~500N |
| E08 | EEV Initial Steps for Cooling | The throttling device on the main circuit of the fluorine system is at the initial position of the refrigeration mode, and it is in this position for a period of time when the fluorine system is just started | 0~500N |
| E09 | EVI EEV: Adjustment Mode | Configure the regulation mode of the electronic expansion valve, which must be set to 1 - automatic | 0-Manual 1-Auto |

| Code | Name | Description | Range |
|-------------|--|---|--------------|
| E10 | EVI EEV: Initial Steps | For the fluorine system with enthalpy gain, the initial opening of the throttling device on the enthalpy gain circuit is at this opening for a period of time when the enthalpy gain circuit is turned on | 0~500N |
| E13 | EVI EEV: Target Superheat Degree | Control the state of the refrigerant supplemented by the vapor-injected enthalpy gain circuit to ensure that the refrigerant is in a gas-liquid mixed state | -20~20°C |
| E14 | EVI: Min. Steps | Control the minimum opening of the throttling device on the vapor-injected enthalpy gain circuit | 0~500N |
| E17 | Defrosting EEV Steps | The fixed opening of the throttling device on the main circuit during defrosting is usually set to the maximum opening of the throttling device to meet the requirements of defrosting on the refrigerant circulation volume and capacity | 0~500N |
| E18 | Target Superheat for Cooling | Control the evaporation and condensation of the fluorine system to achieve a balance to ensure that the heat exchange of the fluorine system is in the best state | -10~10°C |
| E19 | EEV Adjustment Range In Smart Mode | Reserved function, custom configuration. | 0~300% |
| E03-1 | Segment 1 of EEV Initial Steps for Heating | Reserved function, custom configuration. | 0~500N |
| E03-2 | Segment 2 of EEV Initial Steps for Heating | Reserved function, custom configuration. | 0~500N |
| E03-3 | Segment 3 of EEV Initial Steps for Heating | Reserved function, custom configuration. | 0~500N |
| E03-4 | Segment 4 of EEV Initial Steps for Heating | Reserved function, custom configuration. | 0~500N |
| E03-5 | Segment 5 of EEV Initial Steps for Heating | Reserved function, custom configuration. | 0~500N |
| E07-1 | Segment 1 of EEV Min. Steps | Reserved function, custom configuration. | 0~500N |
| E07-2 | Segment 2 of EEV Min. Steps | Reserved function, custom configuration. | 0~500N |

| Code | Name | Description | Range |
|-------------|--------------------------------|--|--------------|
| E07-2 | Segment 2 of EEV Min. Steps | Reserved function, custom configuration. | 0~500N |
| E07-3 | Segment 3 of EEV Min. Steps | Reserved function, custom configuration. | 0~500N |
| E07-4 | Segment 4 of EEV Min. Steps | Reserved function, custom configuration. | 0~500N |
| E07-5 | Segment 5 of EEV Min. Steps | Reserved function, custom configuration. | 0~500N |

6.6. Temp.

| Code | Name | Description | Range |
|-------------|--|--|--------------|
| R01 | DHW Target Temp. | User-set domestic hot water (DHW) temperature. | R36~R37 |
| R02 | Heating Target Temp. | User-set heating temperature. | R10~R11°C |
| R03 | Cooling Target Temp. | User-set cooling temperature. | R08~R09°C |
| R04 | Temp. Diff. For Power-on in Heating | After the heat pump is shut down at constant temperature in heating mode, when the water temperature drops below R04, the heat pump will start again | 0~10°C |
| R05 | Temp. Diff. For Standby in Heating | During startup in heating mode, when the water temperature reaches the target temperature + R05 or higher, the heat pump will shut down | 0~10°C |
| R06 | Temp. Diff. For Power-on in Cooling | After the heat pump is shut down at constant temperature in refrigeration mode, when the water temperature rises above R06, the heat pump will start again | 0~10°C |
| R07 | Temp. Diff. For Standby in Cooling | During startup in refrigeration mode, when the water temperature reaches the target temperature - R07 or lower, the heat pump will shut down | 0~10°C |
| R08 | Min. Cooling Target Temp. | This parameter limits the minimum target temperature for refrigeration that your user can set | -30~28°C |
| R09 | Max. Cooling Target Temp. | This parameter limits the maximum target temperature for refrigeration that your user can set | 5~80°C |
| R10 | Min. Heating Target Temp. | This parameter limits the minimum target temperature for heating that your user can set | -30~70°C |
| R11 | Max. Heating Target Temp. | This parameter limits the maximum target temperature for heating that your user can set | 15~99°C |

| Code | Name | Description | Range |
|-------------|--|--|--|
| R15 | Temp. Diff. Of Exiting Overhigh Outlet Temp. | After the heat pump reports the water outlet overtemperature protection fault and shuts down, when the water temperature drops below R12, the heat pump will exit the shutdown protection state. | 0~15°C |
| R16 | Temp. Diff. For Power-on in DHW | After the heat pump is shut down at constant temperature in hot water mode, when the water temperature in the water tank drops below R16, the heat pump will start again. | 0~10°C |
| R17 | Temp. Diff. For Stand-by in DHW | During startup in hot water mode, when the water temperature in the water tank reaches the target temperature + R17 or higher, the heat pump will shut down | 0~10°C |
| R29 | Low AT for Water Temp. Limit On | R29, R30, R31, R32, R33, R34 and R62 parameters configure the maximum water outlet temperature of the heat pump at different ambient temperatures mainly based on the safe operating range of the heat pump and its compressor, and according to the results of laboratory verification. | -20~4°C |
| R30 | Low AT for Water Temp. Limit Off | | -35~-7°C |
| R31 | Max. Limit Outlet Water Temp. at Low AT | | 20~85°C |
| R32 | High AT for Water Temp. Limit On | | 10~43°C |
| R33 | High AT for Water Temp. Limit Off | | 10~60°C |
| R34 | Max. Limit Outlet Water Temp. at High AT | | 20~85°C |
| R35 | Location of Electric Heater | Change the parameters according to whether electric heating is mounted or not, and the location where the electric heating is mounted. This parameter is mainly used to configure the electric heating control plan of Stage 1 and Stage 2 on the terminals. | 0-Not Available 1-Main Water Circuit 2-DHW Tank 3-Buffer Tank |
| R36 | Min. DHW Target Temp. | This parameter limits the minimum target temperature for hot water that your user can set | 0~70°C |
| R37 | Max. DHW Target Temp. | This parameter limits the maximum target temperature for hot water that your user can set | 25~85°C |
| R39 | AT for Auto-Start Heating Mode | For room insulation, in heating mode, if the room temperature control plan is used (H25=1), when the room temperature is lower than R39, the heat pump will automatically start heating until the room temperature is $\geq R39+5^{\circ}\text{C}$ | 5~20°C |

| Code | Name | Description | Range |
|-------------|---|--|--------------|
| R42 | Max. Outlet Water Temp. in Heating | R29, R30, R32, R33, R42, R43 and R44 parameters correct the maximum target temperature for heating during heat pump running mainly based on the safe operating range of the heat pump and its compressor, according to the results of laboratory verification, and combined with the maximum water outlet temperature of the heat pump at different ambient temperatures. | 20~85°C |
| R43 | Max. Limit Target Water Temp. at Low AT in Heating | | 20~85°C |
| R44 | Max. Limit Target Water Temp. at High AT in Heating | | 20~85°C |
| R45 | AT to Start Electric Heater Without Delay | When the ambient temperature is lower than R45, the electric heating will start synchronously with the compressor without delay time. | -50~20°C |
| R46 | Temp. Diff. Between Max. DHW Target Temp. & Max. Outlet Temp. | The difference between the maximum target temperature for hot water and the maximum water outlet temperature of the heat pump in hot water mode. In general, the temperature of the water tank cannot reach the maximum water outlet temperature of the heat pump due to the uneven distribution of the water temperature in the water tank. This parameter can correct the control logic. | 0~25°C |
| R60 | AT to Start Frequency Limit in Cooling | When the heat pump runs at high ambient temperature for refrigeration, the running frequency needs to be limited to prevent the driver board from overheating and overloading (cooperate with C11) | 0~60°C |
| R61 | AT to Stop Frequency Limit in Cooling | When the heat pump runs at high ambient temperature for refrigeration, the running frequency needs to be limited to prevent the driver board from overheating and overloading (cooperate with C11) | 0~60°C |
| R62 | Max. Heat Pump Outlet Water Temp. | This parameter is the maximum water outlet temperature that the heat pump can achieve, and it is also the protection value for the heat pump to report water outlet overtemperature protection. | 40~95°C |
| R70 | Target Room Temp. | Setpoint temperature in the room for the thermostat. | 5~27°C |
| R71 | Room Temp. Diff. For Power-on in Heating | Temperature difference in the room between the setpoint and the actual temperature to initiate the heating mode. | 0.1~3°C |
| R72 | Room Temp. Diff. For Standby in Heating | Temperature difference in the room between the setpoint and the actual temperature to end the heating mode. | 0.1~3°C |
| R73 | Room Temp. Diff. For Power-on in Cooling | Temperature difference in the room between the setpoint and the actual temperature to initiate the cooling mode. | 0.1~3°C |
| R74 | Room Temp. Diff. For Standby in Cooling | Temperature difference in the room between the setpoint and the actual temperature to end the cooling mode. | 0.1~3°C |

6.7. Pump

| Code | Name | Description | Range |
|------|--------------------------------------|--|---------------------------------------|
| P01 | Main Circulation Pump Operation Mode | Determines how the internal water pump operates in the device. | 0-Always On 1-Saving |
| P02 | Interval Time | Time between stopping the circulation pump and restarting. | 1~120min |
| P03 | Operation Duration Time | Time from pump start to pump stop. | 1~30min |
| P05 | DHW Pump Operation Mode | Circulation pump for domestic hot water works in the following way. | 0-Always On 1-Saving 2-Interval |
| P06 | Main Circulation Pump Manual Control | Manual control of the circulation pump. | 0-NO 1-YES |
| P08 | Main Circulation Pump Rated Power | Specifies the power of the circulation pump. | 0~2000W |
| P09 | Circulation Pump Protection Period | Number of days for the protection of the circulation pump. | 0-30 days |
| P10 | Speed of Circulation Pump | In the case of the circulation pump operating at a constant flow rate, it determines the efficiency as a percentage. | 0~100% |

6.8. Compressor

| Code | Name | Description | Range |
|------|--|---|----------|
| C01 | Manual Comp. Frequency | Set the compressor operating frequency to C01, which is typically used for debugging the heat pump. | 0~120Hz |
| C02 | Min. Comp. Frequency | The operating frequency of the compressor > C02. | 20~60Hz |
| C03 | Max. Comp. Frequency | The operating frequency of the compressor < C03 | 30~120Hz |
| C04 | Model Selection | Depending on the compressor used by the heat pump, you should adjust the appropriate parameters of the frequency converter. | 0~99 |
| C05 | Min. Comp. Frequency in Cooling at Low Ambient Temp. | The compressor operating frequency at low temperatures is >C05 | 0~60Hz |

| Code | Name | Description | Range |
|-------------|---|--|--------------|
| C06 | Frequency Control Mode | When H34=1 or H34=2, it is used to configure the parameters of the ERP mode operation. | 1~120Hz |
| C07 | Resonance Point 1 | Some heat pumps may experience resonance between structural components and the compressor at certain frequencies, causing excessive noise. It is recommended to determine the maximum points of these resonances in a laboratory. With settings C07, C08, and C09, the compressor will automatically avoid these frequencies during operation. | 1~120Hz |
| C08 | Resonance Point 2 | | 1~120Hz |
| C09 | Resonance Point 3 | | 1~120Hz |
| C10 | Min. Comp. Frequency in Heating at Low Ambient Temp. | In the case of heating at very low ambient temperatures and when the compressor frequency is lower than C10, there may be a situation where COP < 1. Therefore, the heating frequency at very low ambient temperatures is set to > C10. | 0~120Hz |
| C11 | Max. Comp. Frequency in Cooling at High Ambient Temp. | When the heat pump operates in high ambient temperatures for cooling, the operating frequency must be limited to prevent overheating and overloading of the control board. | 0~120Hz |
| C12 | Max. Comp. Frequency in DHW mode | When the heat pump operates in low ambient temperatures in the domestic hot water (DHW) mode, the operating frequency must be limited to prevent overheating and overloading of the control board. | 0~120Hz |

6.9. Disinfection

| Code | Name | Description | Range |
|-------------|-------------------------------|--|--------------|
| G01 | Disinfection Water Temp. | Specifies the temperature to which the heat pump should heat the water in the domestic hot water tank. | 60~70°C |
| G02 | Time Duration of Disinfection | Specifies the number of minutes the disinfection temperature will be maintained. | 0~60min |
| G03 | Disinfection Starting Time | Specifies the time at which the disinfection mode will be activated. | 0~23h |

| Code | Name | Description | Range |
|-------------|---------------------------------|--|---------------|
| G04 | Interval Period of Disinfection | Specifies the days of the break between disinfection cycles. | 1~30days |
| G05 | Enable Disinfection | Specifies whether the disinfection function is available. | 0-NO 1-YAS |

6.10. Zone

| Code | Name | Description | Range |
|-------------|---------------------------------|---|---------------------------|
| Z01 | Enable Multi-Zone Control | Selection of multi-zone operation mode: 0 = OFF, 1 = Circuit 1 Room Temperature, 2 = Circuit 2 Room Temperature, 3 = Circuits 1 and 2 Room Temperature, 4 = Circuit 1 Dedicated Room Thermostat, 5 = Circuit 2 Dedicated Room Thermostat, 6 = Circuits 1 and 2 Dedicated Room Thermostat, 7 = Circuit 1 Passive Room Thermostat, 8 = Circuit 2 Passive Room Thermostat, 9 = Circuits 1 and 2 Passive Room Thermostat. | Check 'Controller manual' |
| Z02 | Zone 1 Target RT | Set room temperature for circuit 1. | 10~35°C |
| Z03 | Zone 1 RT Diff. to Start | Temperature difference between the set value and the actual value in the room to start circulation pump 1. | 0~10°C |
| Z04 | Zone 2 Target RT | Set temperature in the room for circuit 2. | 10~35°C |
| Z05 | Zone 2 RT Diff. to Start | Temperature difference between the set value and the actual value in the room to start circulation pump 2. | 0~10°C |
| Z06 | Zone 1 Heating Target Outlet WT | Target water temperature in heating mode for circuit 1. | 16~70°C |

| Code | Name | Description | Range |
|-------------|--|--|---------------|
| Z07 | Zone 2 Heating Target Outlet WT | Target water temperature in heating mode for circuit 2. | 16~70°C |
| Z08 | Mixing Valve Manual Adjustment Ratio (0% for Auto Control) | In the case of manual control of the mixing valve, it determines the percentage opening. | 0~100% |
| Z09 | Mixing Valve Opening Time | The opening time of the mixing valve. | 0~2000s |
| Z10 | Mixing Valve Closing Time | The closing time of the mixing valve. | 0~2000s |
| Z09 | Mixing Valve Opening Time | The opening time of the mixing valve. | 0~2000s |
| Z10 | Mixing Valve Closing Time | The closing time of the mixing valve. | 0~2000s |
| Z11 | Mixing Valve Adjustment P (PID) | Determines the proportional control of the regulator. | 0~10 |
| Z12 | Mixing Valve Adjustment I (PID) | Determines the integral control of the regulator. | 0~10 |
| Z13 | Mixing Valve PID Period | Determines the control time. | 1~20min |
| Z14 | Steps of Mixing valve in Cooling | Determines the percentage range of the mixing valve in cooling mode. | 0~100% |
| Z15 | Zone 2 Max. Water Target Temp. | Upper limit of water temperature for circuit 2. | 15~99°C |
| Z16 | Enable AT Compensation Curve Zone 1 | Determines the activity of the temperature compensation curve for circuit 1. | 0-NO 1-YES |
| Z17 | Enable AT Compensation Curve Zone 2 | Determines the activity of the temperature compensation curve for circuit 2. | 0-NO 1-YES |
| Z19 | Diff. of No Pump On at Low Water Temp. | The temperature difference for not activating the pump at low water temperature | 0~25°C |
| Z20 | Enable Zone 1 Water Pump in Cooling | Determines whether the circulation pump for circuit 1 should be activated in cooling mode. | 0-NO 1-YES |

6.11. SG Ready

| Code | Name | Description | Range |
|------|---|---|--|
| SG01 | SG Ready Application | Determines whether the Smart Grid function should be enabled (See 'Controller User Manual'). SG READY control mode: 0 = inactive, 1 = single potential-free contact, 2 = double potential-free contact. | 0-Disabled 1-One Dry Contact 2-Two Dry Contact |
| SG02 | Block Time of Mode 1 | Determines the sleep mode lockout time. | 0~120min |
| SG03 | Limited Power in Solar Low Mode 2 | Determines the device power in low sunlight mode. | 0~99,9kW |
| SG04 | Limited Power in Solar Medium Mode 3 | Determines the device power in moderate sunlight mode. | 0~99,9kW |
| SG05 | Additional Hot Water Temp. in Mode 4 | Determines the water reheating temperature in the DHW tank above the set value in high sunlight mode. | 0~25°C |
| SG06 | Additional Heating Water Temp. in Mode 4 | Determines the heating water reheating temperature above the set value in high sunlight mode. | 0~25°C |
| SG07 | Additional Cooling Water Temp. in Mode 4 | Determines the water cooling temperature below the set value in high sunlight mode. | 0~25°C |
| SG08 | Turn On the Electric Heater Immediately in Mode 4 | Determines whether the electric heaters should operate in high sunlight mode. | 0-NO 1-YES |

7.7. The logic of device operation.

7.1. The logic of switching between hot water mode and heating/cooling mode.

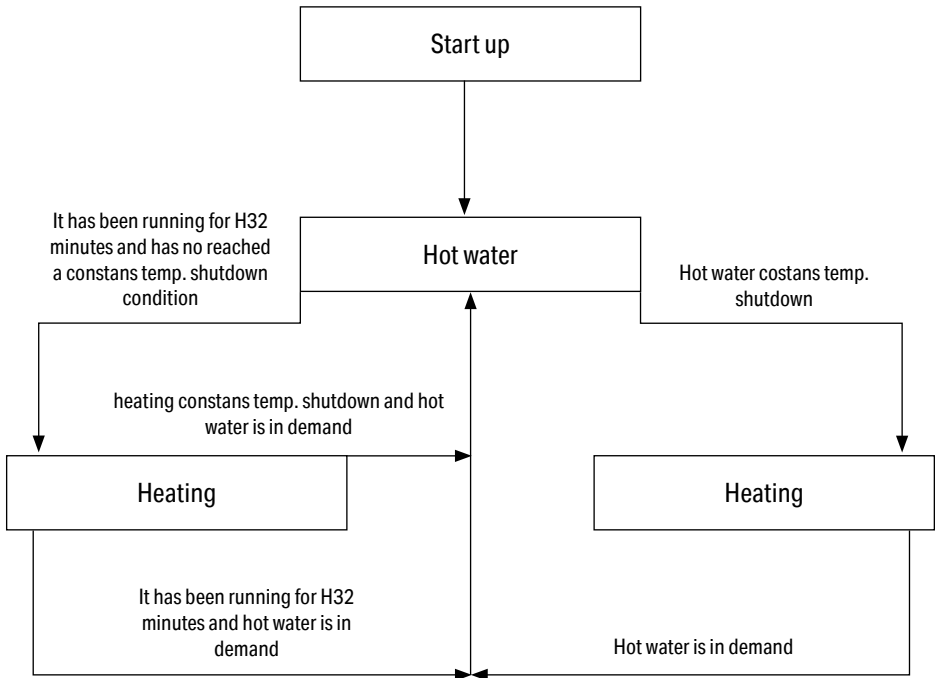

7.2. Compressor control.

1. The compressor can be turned off only after 2 minutes of operation and can be turned on only after a 3-minute break.
2. The compressor must be maintained at 40 Hz for 3 minutes after startup.
3. After the compressor starts, the frequency is calculated by a PID algorithm based on the target temperature and water temperature. System parameters such as ambient temperature, outlet water temperature, and outlet temperature and pressure restrict the compressor's operation. These parameters adjust the previously calculated frequency to achieve the final working frequency.
4. When the target frequency is higher than the current frequency, the frequency is maintained for 3 minutes before increasing to the target frequency.
5. When the target frequency is lower than the current frequency, the frequency is maintained for 3 minutes before decreasing to the target frequency.
6. During normal startup, the compressor accelerates by 6 Hz/60 s and decelerates by 6 Hz/60 s

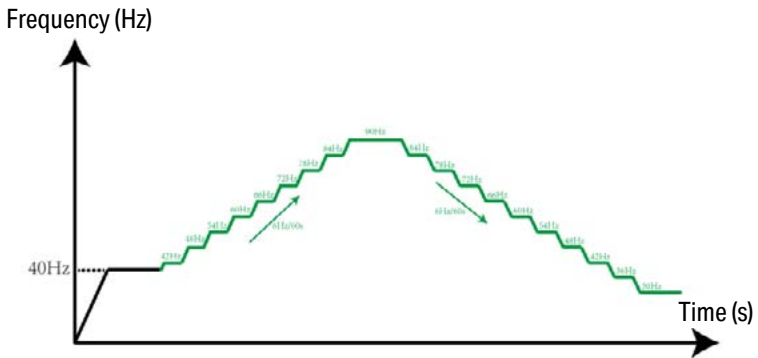

- 7. Within 10 minutes after the heat pump exits defrost mode, the compressor accelerates by 6 Hz/30 s and decelerates by 6 Hz/30 s.

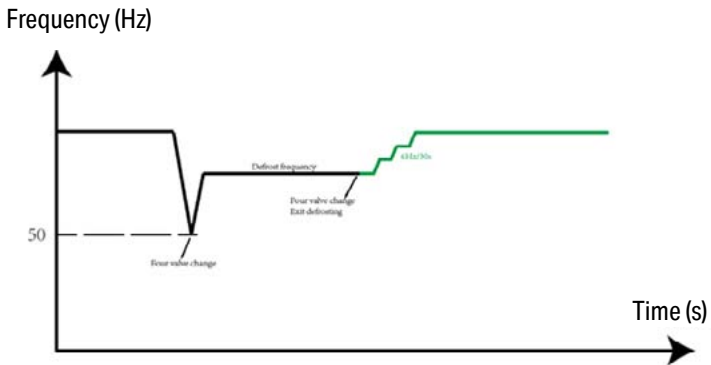

7.3. Fan control

The fan starts 10 seconds before the compressor. The fan turns off 30 seconds after the compressor is turned off.

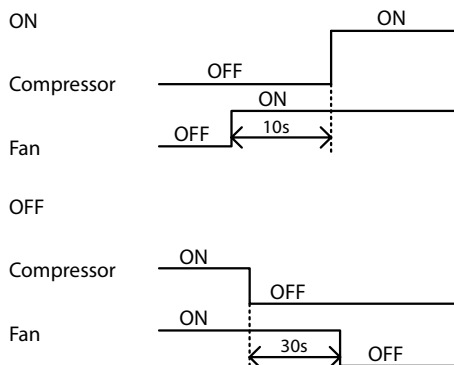

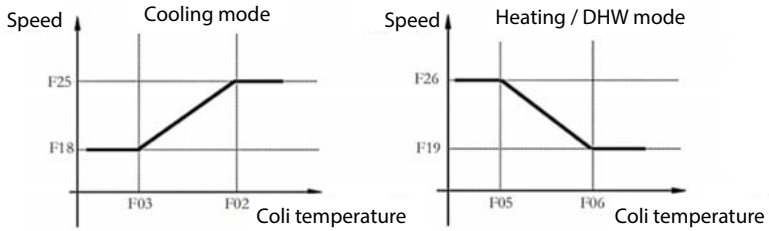

7.4. Main circulation pump control

When H30=0, the hydraulic module is not activated, and the main circulation pump is controlled by the heat pump. Detailed information is available in the heat pump circuit diagram.

When H30=1, the hydraulic module is activated, and the main circulation pump is controlled by the hydraulic module. Detailed information is available in the hydraulic module circuit diagram. After normal startup, the main circulation pump starts 1 minute before the compressor. After normal power-off, the main circulation pump turns off 2 minutes after the compressor.

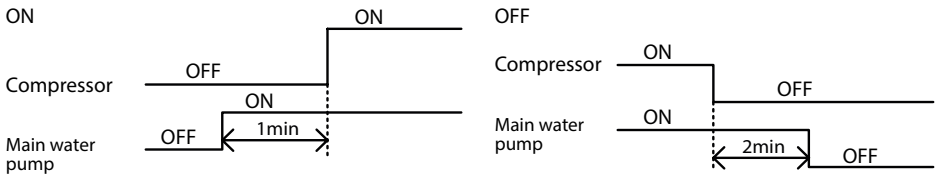

In conditions of constant temperature shutdown, the control mode for the main circulation pump is as follows (P01 in heating mode, P05 in hot water mode):

1. P01/P05 = 0; The pump is continuously on.
2. P01/P05 = 1; The pump turns off after 2 minutes.
3. P01/P05 = 2; The pump operates intermittently, as shown below.

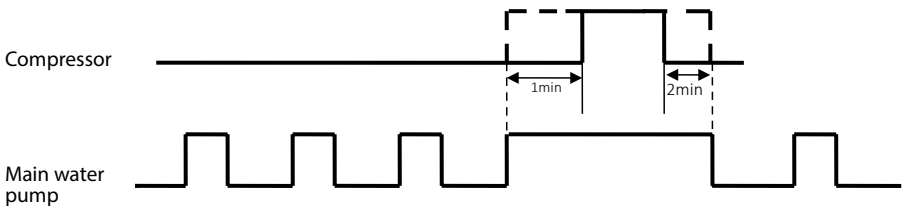

7.5. The main circulation pump protection mode

When P09=0, there is no pump protection mode activation cycle. When the main circulation pump has been off for 6 hours, it will run for 1 minute, toggling to prevent water circulation blockage. If P09≠0, the pump protection mode activation cycle is set to P09 days. When the main circulation pump has been off for P09 days, it will run for 1 minute, toggling to prevent water circulation blockage.

P09=0

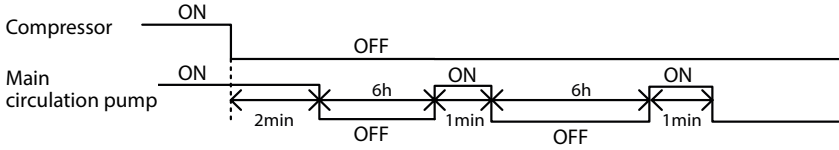

P09≠0

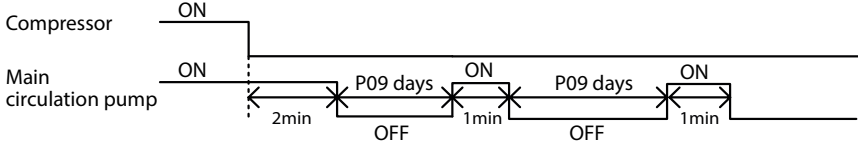

7.6. Circulating pump for domestic hot water

Only when manually turned off, the device can manually control the pump performance function.

| P06 | Manual control of the circulation pump | Function |
|-----|--|---|
| 0 | NO | The circulation pump and the circulating pump for domestic hot water are turned off |
| 1 | YES | The circulation pump and the circulating pump for domestic hot water are turned on. |

7.7. Circulating pump for domestic hot water

When the device is turned on and operating in the hot water mode, the circulating pump for domestic hot water starts 1 minute before the compressor. When the device is turned off, the circulating pump for domestic hot water turns off 2 minutes after the compressor starts. In the constant-temperature shutdown mode, the control mode for the circulating pump for domestic hot water is as follows: When P05=0, the circulating pump for domestic hot water continues to operate; when P05=1, the circulating pump for domestic hot water turns off 2 minutes after the compressor starts; when P05=2, the circulating pump for domestic hot water operates intermittently, as shown below.

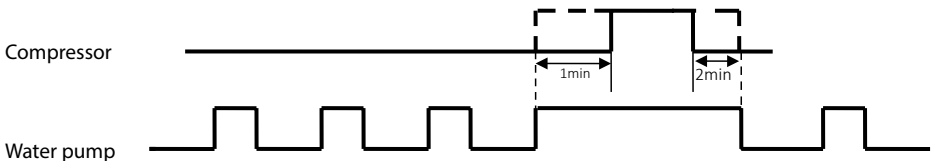

Note:

In the mixed mode, when the heating mode is switched to the hot water mode, the circulating pump for domestic hot water may only start if the water temperature at the outlet > water tank temperature + 1°C.

7.8. Electric Heater Control

1. When R35=0, the electric heater is not turned on.
2. When R35=1 and H30=0, the electric heater for the water circuit is turned on, and the hydraulic module is not activated. Electric heaters can be operated in both heating and hot water modes, and their power is controlled by the heat pump.

| Conditions for activating the electric heater (all must be met) | Initial state | Conditions for deactivating the electric heater (one must be met) |
|---|---|---|
| <ol style="list-style-type: none"> 1. The compressor is on, and the ambient temperature <A31. 2. In heating mode, the water temperature at the outlet \leqR02-R04-A33; In hot water mode, the tank temperature \leqR01-R16-A33°C. 3. The water flow switch is closed. 4. | <ol style="list-style-type: none"> 1. When H18 is 1, and the compressor runs for A32 minutes, electric heater level 1 is activated. 2. When H18 is 2, and the compressor runs for A32 minutes, electric heater level 1 is activated. If the device still cannot meet the heating demand after an additional A32*2 minutes of operation, electric heater level 2 is activated, and electric heater level 1 is deactivated. 3. When H18 is 3, and the compressor runs for A32 minutes, electric heater level 1 is activated. If the device still cannot meet the heating demand after an additional A32*2 minutes of operation, electric heater level 2 is activated. After another A32*3 minutes of operation without meeting the heating demand, both electric heater level 1 and electric heater level 2 are activated. | <ol style="list-style-type: none"> 1. In heating mode, the water temperature at the outlet \geq R02 - A35; In hot water mode, the water tank temperature \geq R01 - A35. 2. Switch mode/turn off. 3. Water flow error. |

| | | |
|---|--|--|
| <ol style="list-style-type: none"> 1. Ambient temperature \leq parameter R45. 2. In heating mode, the water temperature at the outlet \leq R02 - R04 - A33; In hot water mode, the water tank temperature \leq R01 - R16 - A33°C. 3. Water flow switch is closed. | <p>Both power levels of electric heater 1 and electric heater 2 are activated.</p> | <ol style="list-style-type: none"> 1. In heating mode, the water temperature at the outlet is \geqR02-A35; In hot water mode, the water temperature in the water tank is \geqR01-A35. 2. Switch on/off mode. 3. Water flow error. |
| <ol style="list-style-type: none"> 1. The water flow switch is closed. 2. In the on state, in both heating and hot water modes, if the water temperature at the inlet is lower than 2°C for 15 minutes. | <p>Both the power level of electric heater 1 and the power level of electric heater 2 are turned on.</p> | <ol style="list-style-type: none"> 1. In heating mode, the water temperature at the outlet is \geqR02-A35; in hot water mode, the temperature of the water tank is \geqR01-A35. 2. Switch on/off. 3. Water flow error. 4. Inlet water temperature \geq15°C. |

3. When R35=2 and H30=0, the electric heater of the DHW tank is turned on, and the hydraulic module is not turned on. The device can be activated when operating in the hot water mode, and the power is controlled by the heat pump.

| Conditions for activating the electric heater (all must be met) | Initial state | Conditions for deactivating the electric heater (one must be met) |
|--|---|---|
| <ol style="list-style-type: none"> 1. The compressor is on, and the ambient temperature is <A31. 2. In the hot water mode, the tank temperature is $\leq R01-R16-A33^{\circ}C$. 3. | <ol style="list-style-type: none"> 1. When H18 is 1 and the compressor operates for A32 minutes, electric heater level 1 is activated. 2. When H18 is 2 and the compressor operates for A32 minutes, electric heater level 1 is activated, and if the device still cannot meet the heating demand after the next A32*2 minutes of operation, electric heater level 2 is activated, and electric heater level 1 is deactivated. 3. When H18 is 3 and the compressor operates for A32 minutes, electric heater level 1 is activated, and if the device still cannot meet the heating demand after the next A32*2 minutes of operation, electric heater level 2 is activated, and after the next A32*3 minutes, if the device still cannot meet the heating demand, both electric heater level 1 and electric heater level 2 are activated. | <ol style="list-style-type: none"> 1. 1) In hot water mode, the water tank temperature should be greater than or equal to R01-A35. 2. 2) Switch mode/off. |
| <ol style="list-style-type: none"> 1. Ambient temperature \leq parameter R45. 2. In hot water mode, the water tank temperature should be less than or equal to R01-R16-A33$^{\circ}C$. | <p>Both the power level of electric heater 1 and the power level of electric heater 2 are activated.</p> | <ol style="list-style-type: none"> 1. In hot water mode, the water tank temperature should be $\geq R01 - A35$. 2. Switch mode/off. 3. The ambient temperature should be $>$ parameter R45 + 2$^{\circ}C$. |
| <ol style="list-style-type: none"> 1. In the on state, in both heating and hot water modes, if the water temperature at the inlet is lower than 2$^{\circ}C$ for 15 minutes. | <p>Both the power level of electric heater 1 and the power level of electric heater 2 are turned on.</p> | <ol style="list-style-type: none"> 1. In hot water mode, the water temperature in the tank must be $\geq R01-A35$. 2. Switch on/off. 3. The water temperature at the inlet must be $\geq 15^{\circ}C$. |

4. If R35=3 and H30=0, the electric heater of the buffer tank is turned on, and the hydraulic module is not turned on. The device can be activated when operating in heating mode, and the power is controlled by the heat pump.

| Conditions for activating the electric heater (all must be met) | Initial state | Conditions for deactivating the electric heater (one must be met) |
|--|---|--|
| <ol style="list-style-type: none"> 1. The compressor is on, and the ambient temperature is <A31. 2. In heating mode, the water temperature at the outlet is $\leq R02-R04-A33$. 3. The water flow switch is closed. | <ol style="list-style-type: none"> 1. When H18 is 1, and the compressor operates for A32 minutes, electric heater stage 1 is activated. 2. When H18 is 2, and the compressor operates for A32 minutes, electric heater stage 1 is activated. If the device still cannot meet the heating demand after an additional A32*2 minutes of operation, electric heater stage 2 is activated, and electric heater stage 1 is deactivated. 3. When H18 is 3, and the compressor operates for A32 minutes, electric heater stage 1 is activated. If the device still cannot meet the heating demand after an additional A32*2 minutes of operation, electric heater stage 2 is activated. After an additional A32*3 minutes, if the device still cannot meet the heating demand, both electric heater stage 1 and electric heater stage 2 are activated. | <ol style="list-style-type: none"> 1. In heating mode, the water temperature is... 2. Switch mode/off. 3. Water flow error. |
| <ol style="list-style-type: none"> 1. Ambient temperature \leq parameter R45; 2. In heating mode, the water temperature at the outlet $\leq R02-R04-A33$; 3. Water flow switch is closed. | <p>Both the power level of electric heater 1 and the power level of electric heater 2 are turned on.</p> | <ol style="list-style-type: none"> 1. In heating mode, the water temperature at the outlet is $\geq R02-A35$. 2. Switch on/off. 3. Water flow error. 4. Ambient temperature > parameter R45 + 2°C. |

| | | |
|--|---|---|
| <ol style="list-style-type: none"> 1. Flow switch is closed. 2. In the on state, in heating and hot water mode, the water temperature at the inlet is lower than 2°C for 15 minutes. | <p>Both Stage 1 and Stage 2 of the electric heater are turned on.</p> | <ol style="list-style-type: none"> 1. In heating mode, the water temperature at the outlet is $\geq R02-A35$. 2. Switch on/off. 3. Water flow error. 4. Water temperature at the inlet $\geq 15^{\circ}\text{C}$. |
|--|---|---|

5. The independent electric heater of the DHW tank can be activated in the DHW mode, which is unrelated to parameter R35.

| Conditions for activating the electric heater (all must be met) | Initial state | Conditions for deactivating the electric heater (one must be met) |
|---|---|--|
| <ol style="list-style-type: none"> 1. After turning on the compressor, when the ambient temperature is A32 min. 2. In DHW mode, the water tank temperature should be $\leq R01-R16-A33^{\circ}\text{C}$. | <p>The independent electric heater for the DHW tank is activated.</p> | <ol style="list-style-type: none"> 1. 1) In hot water mode, the temperature of the DHW tank is equal to or greater than R01-A35. 2. 2) Switch mode/off. |
| <ol style="list-style-type: none"> 1. Ambient temperature \leq parameter R45. 2. In hot water mode, the temperature of the DHW tank is less than or equal to R01-R16-A33°C. | <p>Heating the independent electric heater of the domestic hot water tank is activated.</p> | <ol style="list-style-type: none"> 1. In hot water mode, the temperature of the water tank is $\geq R01-A35$. 2. Switch mode/off. 3. Ambient temperature $>$ parameter R45+2°C. |
| <ol style="list-style-type: none"> 1. In the on state, in heating and hot water mode, the water temperature at the inlet is lower than 2°C for 15 minutes. | <p>Heating the independent electric heater of the domestic hot water tank is activated.</p> | <ol style="list-style-type: none"> 1. In hot water mode, the temperature of the water tank is $\geq R01-A35$. 2. Switch on/off. 3. Inlet water temperature $\geq 15^{\circ}\text{C}$. |

7.9. Manual activation/deactivation of the heater.

In heating or hot water mode, press the “Electric Heater” button, and the corresponding electric heater will be activated (individual stages of electric heaters are activated according to the logic below). When the water temperature reaches the constant temperature hold state (as shown below), the electric heater will be automatically turned off.

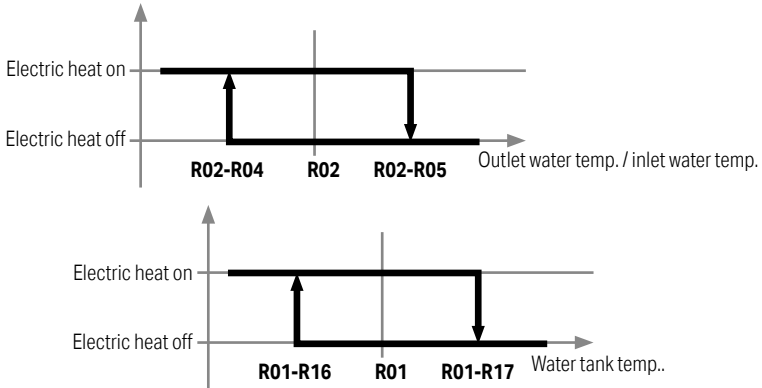

7.10. Disinfection Function

| Access Conditions (all must be met) | After startup | Exit conditions (any one of them is met) | After turning off |
|---|--|---|---|
| <ol style="list-style-type: none"> 1. Start the count-down during hot water mode operation and accumulate up to parameter G04 + 12h. 2. During G03 time (03:00 ~ 03:59), assess that the unit is operating in hot water mode. | <p>Start the compressor, heat the water tank to R37, then turn off the compressor and turn on the electric heater.</p> | <ol style="list-style-type: none"> 1. Water tank temperature \geq parameter G01; 2. Water tank temperature \geq parameter G01-2°C, and the cumulative time is greater than parameter G02; 3. Disinfection time at high temperature exceeding 3 hours; 4. The unit enters the defrost mode; 5. Set G05=0. | <p>The electric heater is turned off.</p> |

Note:

If R35=3, the electric heater of the heating tank is not turned on, then the electric heater of the independent DHW tank will be turned on. In hot water mode, the three-way hot water valve is open for at least 3 seconds before the water pump. When H30=0, the output is controlled by the heat pump. Detailed information is available on the heat pump circuit diagram. When H30=1, the output is controlled by the hydraulic module, and the function is reserved. Detailed information is available on the hydraulic module circuit diagram.

| H20 | DHW mode | Cooling mode |
|-----|--------------------------------|--------------------------------|
| 0 | The three-way valve is open. | The three-way valve is closed. |
| 1 | The three-way valve is closed. | The three-way valve is open. |

7.11. Defrost tray heater control

When the ambient temperature drops below a specified value during defrosting, the defrost tray heater is activated. After the defrosting process is complete, the heater continues to operate for a certain period. Once the ambient temperature exceeds the specified value, the defrost tray heater is turned off.

7.12. Defrost Function Control

- Manual Defrost control

It is possible to manually activate the defrost function in the 'Parameters' menu. Defrost can be enabled while the heat pump is operating in heating or domestic hot water mode. It is not possible to activate defrost during cooling.

| Current operating mode | Is the manual defrost function available? | Conditions for entering manual defrost mode. | Conditions for exiting manual defrost mode (fulfilled one condition). |
|------------------------|---|--|--|
| Cooling | NO | - | - |
| Heating | YES | Touch 'Defrost' to illuminate the icon. | <ol style="list-style-type: none"> Tap the "Manual Defrost Button" to change it to a gray icon; Defrost time \geq D19; Evaporator temperature \geq D17. |
| DHW | | | |

- Automatic Defrost

| Conditions for entering manual defrost mode. | Conditions for exiting manual defrost mode (fulfilled one condition). | Entering/Exiting defrost |
|---|--|---------------------------------------|
| <ol style="list-style-type: none"> 1. The unit is operating in heating or hot water mode; 2. Water temperature at the inlet > D11; 3. Defrost interval \geq D03; 4. Both the outdoor air temperature sensor failure and low-pressure sensor failure occur at the same time; 5. The return air temperature will meet the conditions; 6. Low pressure should meet the conditions. | <ol style="list-style-type: none"> 1. Defrost time \geq D19; 2. Heat exchanger temperature \geq D17. | <p>As shown in the picture below:</p> |

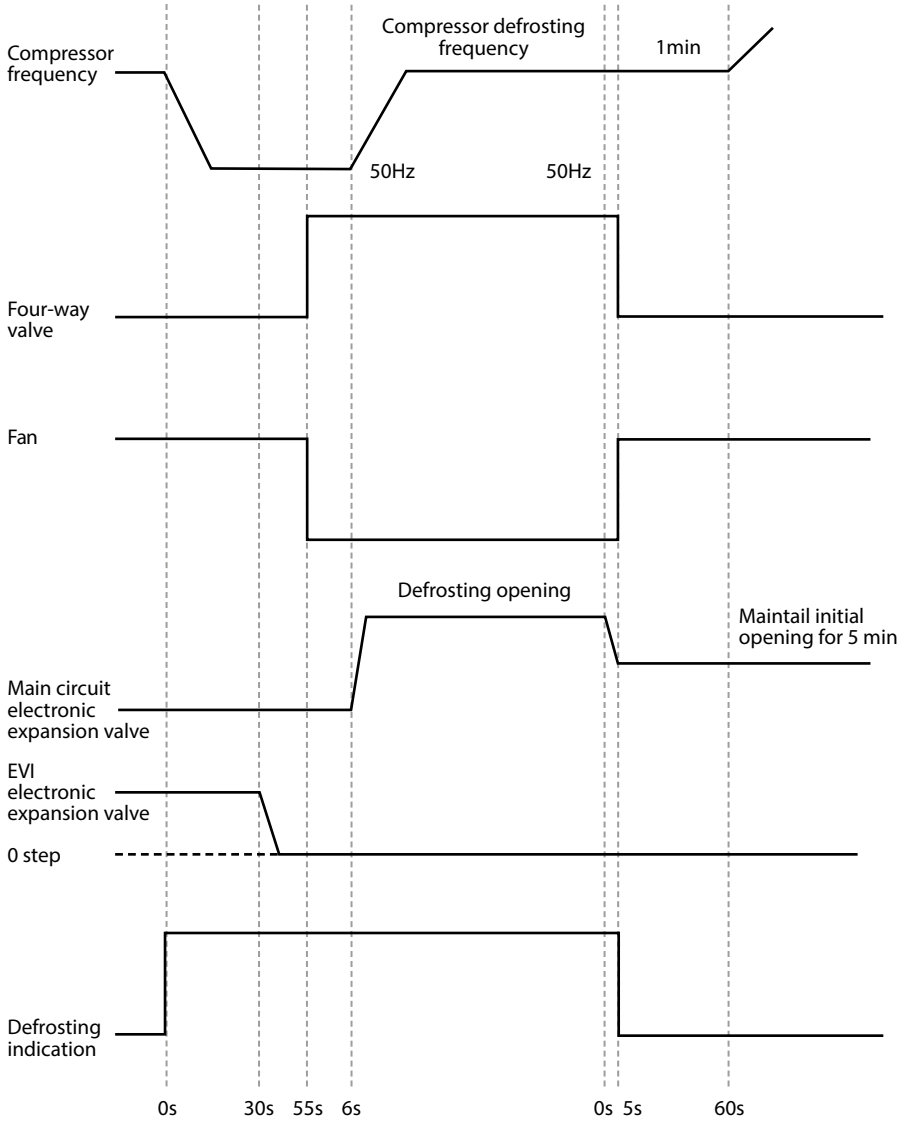

- Controlling the three-way valve during defrost.

| D24 | H20 | Defrost | Position of the three-way valve. |
|------------|------------|----------------------------------|---|
| 0 | 0 | Towards domestic hot water (DHW) | Three-way valve is open |
| | | Towards heating | Three-way valve is closed |
| | 1 | Towards domestic hot water (DHW) | Three-way valve is closed |
| | | Towards heating | Three-way valve is open |
| 1 | 0 | Towards domestic hot water (DHW) | Three-way valve is open |
| | 1 | Towards domestic hot water (DHW) | Three-way valve is closed |
| 2 | 0 | Towards heating | Three-way valve is closed |
| | 1 | Towards heating | Three-way valve is open |

8. Service

8.1. Antifreeze Protection

8.1.1. Too low water temperature at the outlet

| Conditions for entering | Controller response | Conditions of exiting | Actions |
|--|--|---|---|
| During defrosting, the water temperature at the outlet $\leq A23$ is detected for 2 consecutive seconds. | <ol style="list-style-type: none"> The compressor and fan are turned off, and the circulating water pump is still operating. The display does not alarm but records error information. | The water temperature at the outlet is $\geq A23+3^{\circ}\text{C}$. | The device is restarted to operate in heating mode. |
| In cooling mode, the water temperature at the outlet $\leq A23$ is detected for two consecutive seconds after the compressor starts. | | | The device is restarted in cooling mode. |

8.1.2. Protection against freezing in low temperatures (winter period)

| Conditions for entering (all must be met) | Controller response | Conditions of exiting (one must be met) | Actions |
|--|---|--|---|
| <ol style="list-style-type: none"> 1. In cases such as shutdown, lockout, and machine shutdown after 3 faults, as well as shutdown at a constant temperature. 2. $A04 < \text{Inlet Temperature} \leq A04 + 6^{\circ}\text{C}$; 3. Ambient Temperature $\leq 4^{\circ}\text{C}$. | <p>The main circulating pump operates intermittently, turning on for 2 minutes and off for 30 minutes.</p> | <ol style="list-style-type: none"> 1. Ambient temperature $> 4^{\circ}\text{C}$. 2. Water temperature at the inlet $> A04 + 6^{\circ}\text{C}$. | <p>The pump is turned off.</p> |
| <ol style="list-style-type: none"> 1. 1) In cases such as shutdown, lockout, and machine shutdown after 3 faults, as well as shutdown at a constant temperature; 2. 2) $A04 - 2^{\circ}\text{C} < \text{water temperature at the inlet} \leq A04$; 3. 3) Ambient temperature $\leq 0^{\circ}\text{C}$. | <ol style="list-style-type: none"> 1. In winter, the unit enters level 1 anti-freeze protection and automatically starts the water pump. 2. The display does not sound an alarm but records error information. | <ol style="list-style-type: none"> 1. Outlet water temperature $\geq A04 + 4^{\circ}\text{C}$; 2. Ambient temperature $> 1^{\circ}\text{C}$. | <p>The pump is turned off..</p> |
| <ol style="list-style-type: none"> 1. In cases such as shutdown, lockout, and machine shutdown after 3 faults, as well as shutdown at a constant temperature. 2. Water temperature at the inlet $\leq A04 - 2^{\circ}\text{C}$. 3. Ambient temperature $\leq 0^{\circ}\text{C}$. | <ol style="list-style-type: none"> 1. The unit automatically starts and operates in heating mode (frequency is set constant at 51 Hz). 2. The electric heater is activated (electric heater energy level 1 and electric heater energy level 2 are both activated). 3. The display issues an alarm and records fault information. | <ol style="list-style-type: none"> 1. Water temperature at the inlet $\geq A04 + 11^{\circ}\text{C}$. 2. Ambient temperature $> 1^{\circ}\text{C}$. | <ol style="list-style-type: none"> 1. The device exits the heating mode and returns to standby. 2. The display cancels the alarm. |

8.2. Troubleshooting

This section contains useful information to diagnose and troubleshoot issues with the unit. Troubleshooting and repair actions should only be performed by qualified technicians with the necessary training and knowledge. Before proceeding with the troubleshooting procedure, conduct a visual inspection of the device, looking for obvious faults.



WARNING

During the inspection of the unit's electrical box, ensure that the unit is turned off using the main switch.

| Problem | Possible cause | Related components | Diagnostics |
|---|---|--|---|
| The device turns off after power on | Short circuit | Terminals Relays Contactors Wires | Check the connection of all components. Verify that relays and contactors are not damaged. Disconnect electronic elements one by one and power on to identify the problem. |
| Display does not turn on | Disconnection of wires Incorrect power cable connection | Display cable Power cable | Check the display cable (sequence of wires) Check the power cable Verify if the 3-phase power cable is connected in the correct phase sequence. |
| The device cannot be started. | Unit error Disconnection of wires | Display Cables | Check if an error appeared on the display Check the cable Reconnect the power cable and check if it works |
| Display does not work | Lock of the display Damage to the display | Display | Check if the lock icon is displayed on the screen Check the cable Reconnect the power cable and check if it works |
| Weak heating | Compressor operates at low frequency Fan is not working or speed is too low Leakage problem | Compressor Fan Refrigerant system | Check the compressor operating frequency Check the fan rotation speed Check the temperature and pressure of the refrigerant |
| Shutdown when the target temperature is not reached | Temperature limit reached (depending on ambient temperature) | Control logic | Check parameters |

| | | | |
|---|--|---|--|
| The evaporator has too much frost, and it cannot be completely defrosted. | Issue with the fan blade or fan motor Incorrect setting of the EEV valve Problem with the refrigerant quantity Issue with defrosting parameters | Parameters Fan EEV Refrigerant system | Check defrosting parameters Check compressor frequency Check fan rotation speed Check temperature and pressure of the refrigerant |
| Unusual noise | Screws Problem with fan blade or motor Problem with compressor Component collision | Screws Fan Compressor Others (cables, pipes) | Check screws Check fan blades and motor Check compressor Check other components |

8.3. Errors on the control board

Reset methods: A = automatic reset; M = manual reset; A/M = Limited automatic reset;

| Error code | Name | Reset | Possible cause | Troubleshooting | Solution |
|------------|-------------------------|-------|--|---|---|
| F00 | Overcurrent IPM Failure | A/M | <ol style="list-style-type: none"> 1. The compressor model code is incorrect; 2. The compressor is improperly connected; 3. The compressor is damaged; 4. The inverter board is damaged. | <ol style="list-style-type: none"> 1. Check if the compressor model code is correct (verify if parameter C04 aligns with the parameter table, and if it's inconsistent, change the model code to the correct one). 2. Check the compressor connection according to the connection diagram, ensuring the connection is correct and the contact is not weak. 3. Check the resistance value between the UV, UW, and VW phases of the compressor using a multimeter in resistance measurement mode. Under normal conditions, the resistance value ranges from 1 to 20 ohms, and the resistance value between each phase is generally equal. If it exceeds the normal range, the compressor is damaged. 4. If all the above are correct, replace the inverter board. | <ol style="list-style-type: none"> 1. Enter the correct compressor model code. 2. Correct the compressor terminals. 3. Replace the compressor. 4. Replace the inverter board. |

| | | | | | |
|------|-----------------------------------|-----|--|---|--|
| F01 | Compressor Drive Error | A/M | <ol style="list-style-type: none"> 1. The compressor model code is incorrect; 2. The compressor is improperly connected; 3. The compressor is damaged; 4. The inverter board is damaged. | <ol style="list-style-type: none"> 1. Check if the compressor model code is correct (verify if parameter C04 aligns with the parameter table, and if it doesn't, change the compressor model code to the correct one). 2. Verify the compressor connection according to the wiring diagram, ensuring that the connection is correct and that there are no weak contacts. 3. Check the resistance value between the UV, UW, and VW phases of the compressor using a multimeter in resistance measurement mode. Under normal conditions, the resistance value ranges from 1 to 20 ohms, and the resistance value between each phase is generally equal. If it exceeds the normal range, the compressor is faulty. 4. If all the above are correct, replace the inverter board. | <ol style="list-style-type: none"> 1. Enter the correct model code for the compressor. 2. Correct the terminals of the compressor. 3. Replace the compressor. 4. Replace the inverter board. |
| E051 | Compressor Overcurrent Protection | A/M | <ol style="list-style-type: none"> 1. The current control module is damaged. 2. The compressor is overloaded. | <ol style="list-style-type: none"> 1. Check the displayed current T36 of the compressor (effective value of phase current), measure the actual current value of the compressor with current clamps, and compare the error between the actual and displayed values. If the current detection result exceeds the specified error range, the current control circuit on the inverter board is damaged. 2. Check the resistance value between the UV, UW, and VW phases of the compressor using a multimeter in resistance measurement mode. Under normal conditions, the resistance value is between 1 ~ 20 ohms, and the resistance value between each phase is generally equal. If it exceeds the normal range, the compressor is damaged. 3. Check other temperature/pressure parameters and investigate the cause of compressor overload in the system. | <ol style="list-style-type: none"> 1. Replace the inverter board. 2. Replace the compressor. 3. Contact after-sales service personnel. |
| F15 | Power phase failure | A | <ol style="list-style-type: none"> 1. Incorrect power connection; 2. Faulty fuse or damaged controller. | <ol style="list-style-type: none"> 1. Check if the power connection terminals are correct and if the contact is good. 2. Verify if the fuse is functional (using a multimeter). 3. If all the above is in order, replace the control board. | <ol style="list-style-type: none"> 1. Correct the power connections on the power supply board, especially on the three-phase power board. 2. Replace the fuse. 3. Replace the control board. |

| | | | | | |
|-----|---|-----|---|--|--|
| F18 | IPM current sampling error | A | 1. The inverter board is damaged. | 1. Turn off the power, wait for 5 minutes, and then turn it on again, trying several times. | 1. If the fault is not resolved, it is recommended to replace the inverter board directly. |
| F26 | Protection against overheating of control board components (shutdown before overheating of power elements). | A | 1. The fan is not rotating, but the current is high; 2. Too little thermally conductive silicone grease on the surface of the module radiator. | 1. Check if the fan is working normally; 2. Check the thermally conductive silicone grease on the inverter board radiator (whether it is evenly distributed and whether there is an appropriate amount); 3. If the above is in order, contact after-sales service personnel. | 1. Resolve issues with the fan and fan control board; 2. Remove the old thermally conductive silicone grease and reapply thermally conductive silicone grease to ensure all gaps are filled; 3. If the problem persists, contact an authorized service center. |
| F03 | PFC error | A/M | 1. Loss of power phase; 2. Power-on after a power failure without complete discharging, frequent power on and off resulting in overheating of the PTC. | 1. Check the connections of the main power terminals and the control board. 2. Try to turn on the power after a 5-minute power interruption. | 1. Correct the connections of the power terminals and the control board. 2. Turn on the power after a long period of being turned off. |
| F05 | DC Bus Overvoltage | A | 1. Check if the supply voltage is too low. 2. The sampling circuit is damaged. | 1. Check if the supply voltage is not too high (single-phase 170-265 V, three-phase 320-460 V). 2. If the voltage (measured multiple times) falls within the normal range and the fault persists after turning off, turning on, and restarting, replace the control board. | 1. Resolve the issue with the power grid. 2. Replace the inverter card if the error persists after restarting. |
| F06 | DC Bus Undervoltage | A | 1. Check if the supply voltage is too low. 2. The sampling circuit is damaged. | 1. Check if the power supply voltage is not too high (single-phase 170-265 V, three-phase 320-460 V). 2. If the voltage (measured multiple times) falls within the normal range and the fault persists after turning off, on, and restarting, replace the control board. | 1. Resolve the issue with the power grid. 2. Replace the inverter card if the error persists after restarting. |
| F07 | Low AC power voltage | A | 1. Power supply voltage is too low. | 1. Check if the power supply voltage is not too high (single-phase 170-265 V, three-phase 320-460 V). 2. If the voltage (measured multiple times) falls within the normal range and the fault persists after turning off, on, and restarting, replace the control board. | 1. Resolve the issue with the power supply. |

| | | | | | |
|-----|--|-----|---|--|---|
| F08 | Exceeding AC Power Current | A | 1. Damaged controller sampling circuit; | 1. Damaged controller sampling circuit; | 1. Replace the control board; 2. If the issue persists, contact an authorized service center. |
| F09 | Error in input voltage sampling. | A | 1. Incorrect input voltage. 2. Input voltage sampling circuit is damaged. | 1. Check if the supply voltage is not too high (single-phase 170-265 V, three-phase 320-460 V). 2. If the voltage (measured several times) is within the normal range, and the fault persists after turning off, turning on, and restarting, replace the control board. | 1. Resolve the issue with the power supply. 2. Replace the inverter card if the error persists after restarting. |
| F17 | Temperature sensor error on the control board. | A | 1. The compressor is incorrectly connected, or there is a weak contact at the connector. 2. The compressor is damaged. | 1. Check the connection between the sensor cable and the terminal. 2. The sensor is damaged. 3. The board is damaged. | 1. Check and correct the sensor terminals. 2. Replace the temperature sensor. 3. Replace the inverter board. |
| F14 | Compressor phase loss | A/M | 1. The compressor is incorrectly connected, or there is a weak contact at the connector. 2. The compressor is damaged. | 1. Check the connection of the compressor according to the wiring diagram to ensure that the connection is correct and that the contact is not weak. 2. Check the resistance value between the UV, UW, and VW phases of the compressor using a multimeter in resistance measurement mode. Under normal conditions, the resistance value is typically between 1 and 20 ohms, and the resistance value between each phase is generally equal. If it exceeds the normal range, the compressor is damaged. 3. If all the above steps are okay, replace the control board | 1. Improve the terminals at the compressor connection. 2. If the compressor is damaged, replace the compressor. 3. Replace the control board. |
| F25 | 15VDC Power Supply Error. | A | 1. Incorrect reading of EEPROM data, EEPROM memory is damaged. | 1. Check 15VDC power supply | 1. Replace the inverter board. |
| F29 | Error in EEPROM memory | M | 1. Incorrect reading of EEPROM data, EEPROM memory is damaged. | 1. The content of EEPROM is incorrect. | 1. Replace the inverter board. |
| F10 | Overvoltage protection of AC power supply. | A | 1. Power supply voltage is too high. 2. Damaged voltage sampling circuit. | 1. Check if the power supply voltage is not too high (single-phase 170-265 V, three-phase 320-460 V). 2. If the voltage (measured several times) is within the normal range and the fault persists after turning off, turning on, and restarting, replace the control board. | 1. First, resolve the issue with the power supply. 2. Replace the inverter card if the error persists after restarting. |

| | | | | | |
|-----|---|---|--|--|--|
| F21 | Protection against excessive compressor speed. | A | <ol style="list-style-type: none"> 1. Incorrect compressor model code. 2. The compressor is connected incorrectly. 3. The controller sampling circuit is damaged. | <ol style="list-style-type: none"> 1. Check if the power supply voltage is not too high (single-phase 170-265 V, three-phase 320-460 V). 2. If the voltage (measured several times) is within the normal range and the fault persists after turning off, turning on, and restarting, replace the control board. | <ol style="list-style-type: none"> 1. First, resolve the issue with the power supply. 2. Replace the inverter card if the error persists after restarting. |
| F33 | Compressor Current Frequency Reduction Alarm | A | <ol style="list-style-type: none"> 1. The working environment is challenging and exceeds the permissible working conditions, causing excessive compressor load. | <ol style="list-style-type: none"> 1. Check if the device is operating within the permissible range of working conditions. | <ol style="list-style-type: none"> 1. Relocate the device or adjust the working conditions. |
| F16 | Alarm for Compressor Flow Weakening Protection | A | <ol style="list-style-type: none"> 1. Compressor model code is incorrect; 2. Incorrect input voltage; 3. Power Factor Correction (PFC) is not enabled. | <ol style="list-style-type: none"> 1. Check if the compressor model code is correct (verify if parameter C04 is consistent with the parameter table; if it's not, the model code is incorrect). 2. Measure the bus voltage and confirm if the input voltage is correct (refer to parameter T37 for the DC bus voltage value). 3. Verify if Power Factor Correction (PFC) is enabled (if the input current T35 value is greater than 3A, it is enabled). | <ol style="list-style-type: none"> 1. Reset the correct compressor model code. 2. Input the correct voltage. 3. Wait for the Power Factor Correction (PFC) function to be activated. |
| F20 | Overheating power element alarm | A | <ol style="list-style-type: none"> 1. The fan is not rotating, and the current is high; 2. Less heat-conducting silicone grease on the bottom of the module. | <ol style="list-style-type: none"> 1. Check if the fan is operating normally; 2. Check the heat-conducting silicone grease on the inverter board's radiator (whether it is unevenly distributed and if there is enough heat-conducting silicone grease); 3. If the above is in order, contact the after-sales service personnel. | <ol style="list-style-type: none"> 1. Resolve issues with the fan and the fan controller board; 2. Remove the old heat-conducting silicone grease and reapply heat-conducting silicone grease to ensure all gaps are filled; 3. In case of no resolution, contact an authorized service center. |
| F22 | Alarm for Decrease in AC Power Supply Frequency | A | <ol style="list-style-type: none"> 1. Operating conditions exceed permissible parameters, causing excessive load on the compressor. | <ol style="list-style-type: none"> 1. Check if the device is operating within acceptable working conditions. Verify the frequency of the electrical network. | <ol style="list-style-type: none"> 1. Adjust the conditions to meet the required operating range of the device. |
| F23 | EEPROM memory alarm | A | EEPROM data read is incorrect, EEPROM memory is damaged | EEPROM data is invalid | <ol style="list-style-type: none"> 1. Replace the inverter board. |
| F24 | EEPROM fault | A | EEPROM data read is incorrect, EEPROM memory is damaged | EEPROM data is invalid | <ol style="list-style-type: none"> 1. Replace the inverter board. |

8.4 Errors of the fan

| Code | Name | Reset | Possible cause | Troubleshooting | Solutions |
|---------------|--|-------|--|---|--|
| F031/ F032 | Faults of Fan 1/ Fan 2 | A | <ol style="list-style-type: none"> 1. Parameter settings are incorrect. 2. Incorrect connection. 3. Fan communication error. 4. Communication error. 5. Damaged fan module or inverter control board. 6. Fan motor is damaged. | <ol style="list-style-type: none"> 1. Check if the fan parameters are correct (parameter F01 is correct). 2. Confirm that the electrical connection positions are correct and in accordance with the circuit diagram. 3. Use a multimeter to measure the voltage change between ports A and B on the main board. If there is no change or the change remains around 0.1 V, the communication port is damaged. 4. Measure whether the voltage between the red and black lines of the fan terminal on the fan control board is 200-370 V DC. If not, it indicates that the power supply is incorrect, and there is an issue with the fan module or the inverter control board. 5. Measure whether the voltage between the white and black lines of the fan terminal on the fan control board is 13.5-16.5 V. If not, it indicates that the power supply is incorrect, and there is an issue with the fan module or the inverter control board. 6. If the above points are correct, replace the motor. | <ol style="list-style-type: none"> 1. Check and reset the fan parameters. 2. Connect and disconnect the terminals. 3. Install the main control panel. 4. Replace the fan speed control board or check the inverter control board. 5. Replace the fan. |
| F120 | Sensor failure temperature (fan) | A | <ol style="list-style-type: none"> 1. The fan control board is damaged. | <ol style="list-style-type: none"> 1. Temperature sensor malfunction, replace the control board. | <ol style="list-style-type: none"> 1. Replace the control board. |
| F106 | Protection against IPM (inverter power module) overheating (fan) | A | <ol style="list-style-type: none"> 1. The fan is not rotating, and the current is high; 2. Too little silicone grease conducting heat on the bottom of the module. | <ol style="list-style-type: none"> 1. Check if the fan is operating normally; 2. Check the silicone grease conducting heat on the radiator of the fan control board (whether it is evenly distributed and whether there is enough of it); 3. If the above is in order, contact an authorized service center. | <ol style="list-style-type: none"> 1. Resolve issues with the fan and the fan control board; 2. Remove old heat-conducting silicone grease and reapply silicone grease, ensuring all gaps are filled; 3. If the above steps do not resolve the issue, contact an authorized service center. |

| | | | | | |
|------|---------------------------------------|-----|--|---|--|
| F105 | Overcurrent protection for IPM (fan). | A/M | <ol style="list-style-type: none"> 1. Incorrect parameter settings; 2. Incorrect fan connection; 3. Something is wrong with the fan module or the inverter control board; 4. Something is wrong with the fan module or the inverter control board. | <ol style="list-style-type: none"> 1. Check if the fan selection parameters are correct. 2. Verify the fan connection according to the wiring diagram, ensuring that the connection is correct and the contact is secure. 3. Measure whether the voltage between the red and black lines of the fan connection terminal on the fan control board is 200-370 V DC. If not, it indicates that the power supply is incorrect, and there is an issue with the fan module or the inverter control board. 4. Measure whether the voltage between the white and black lines of the fan connection terminal on the fan control board is 13.5-16.5 V. If not, it indicates that the power supply is incorrect, and there is an issue with the fan module or the inverter control board. 5. If all the above are fine, replace the inverter control board. | <ol style="list-style-type: none"> 1. Check and reset the fan selection parameters. 2. Reinforce the input terminal of the fan. 3. Replace the fan speed control board or check the inverter control board. 4. Replace the inverter control board. |
| F101 | Protection against phase loss | A/M | <ol style="list-style-type: none"> 1. The fan is improperly connected or the contact is weak; 2. The fan is damaged. | <ol style="list-style-type: none"> 1. Check the fan connection according to the wiring diagram, whether the connection is correct, and if the contact is proper. 2. Measure the resistance value between phases UV, UW, and VW of the fan using a multimeter in resistance measurement mode. Under normal conditions, the resistance value is typically between 1 ~ 20 ohms, and the resistance value between each phase is generally equal. If it exceeds the normal range, the fan is damaged. 3. If everything is in order, replace the fan speed control board. | <ol style="list-style-type: none"> 1. Strengthen the input terminal of the fan. 2. If the fan is damaged, replace the fan. 3. Replace the fan speed control board. |
| F112 | Current Sampling Error (Fan). | A | <ol style="list-style-type: none"> 1. Switching power supply is damaged | <ol style="list-style-type: none"> 1. Check the 15V power supply voltage (difficult, replace the board). | <ol style="list-style-type: none"> 1. Replace the fan speed controller board. |

| | | | | | |
|------|---|-----|---|---|---|
| F102 | Startup of the fan failed (zero speed). | A/M | <ol style="list-style-type: none"> 1. Check if the fan is incorrectly connected or if the contact is weak. 2. The fan is damaged. | <ol style="list-style-type: none"> 1. Check the connection of the fan according to the wiring diagram, ensuring that the connection is correct and the contact is secure. 2. Measure the resistance value between the phases UV, UW, and VW of the fan using a multimeter in resistance measurement mode. Under normal conditions, the resistance value is typically between 1 and 20 ohms, and the resistance value between each phase is generally equal. If it exceeds the normal range, the fan is damaged. 3. If everything is in order, replace the fan speed control board. | <ol style="list-style-type: none"> 1. Correct the terminal connection of the fan. 2. If the fan is damaged, replace the fan. 3. Replace the fan speed control board. |
| F113 | Fan Overcurrent | A/M | <ol style="list-style-type: none"> 1. The current detection module is damaged. 2. The fan load is too high, and the fan speed control board is damaged. | <ol style="list-style-type: none"> 1. Check the displayed current T48 of the fan (external drive fan current), measure the actual fan current using current clamps, and compare the error between the actual values and the displayed values. If the result exceeds the specified error range, the current detection circuit on the fan speed control board is damaged. | <ol style="list-style-type: none"> 1. Replace the fan speed control board. 2. If the fault persists, contact an authorized service center. |
| F109 | Fan Over-Speed Protection | A | <ol style="list-style-type: none"> 1. Incorrect parameter setting; 2. Incorrect fan connection; 3. Faulty fan speed control board. | <ol style="list-style-type: none"> 1. Check if the fan selection parameters are correct. 2. Verify the fan connection according to the wiring diagram to ensure that the connection is correct and the contacts are secure. 3. The fan speed control board is damaged. | <ol style="list-style-type: none"> 1. Check and reset the fan selection parameters. 2. Reinforce the input terminal of the fan. 3. Replace the fan speed control board. 4. If the above steps do not resolve the issue, contact an authorized service center. |

8.5 Communication errors

Reset methods: A = automatic reset; M = manual reset; A/M = Limited automatic reset;

| Code | Name | Reset | Possible cause | Troubleshooting | Solutions |
|---------------|---|-------|--|---|--|
| E08 | Communication error | A | <ol style="list-style-type: none"> 1. Incorrect connection or weak electrical contact; 2. The display is damaged; 3. Communication line is damaged; 4. Communication port on the main board is damaged. | <ol style="list-style-type: none"> 1. Check if the connection is correct (main board and terminal block, terminal block and display). 2. Replace the display to see if the fault is resolved. If the fault is resolved, the display is damaged. 3. Connect the display directly to the main board to check if the fault is resolved. If the fault is resolved, the communication line is damaged. 4. Measure the voltage change between ports A and B on the main board using a multimeter. If there is no change in value or the change remains around 0.1 V, the communication port is damaged. 5. If all of the above are in order, contact an authorized service center. | <ol style="list-style-type: none"> 1. Reconnect. 2. Replace with a new display. 3. Replace the cable. 4. Replace the main board. |
| E081/ E082 | Communication Error (Main Board E081 and DC Fan) / Communication Error (Main Board E082 and DC Fan 2) | A | <ol style="list-style-type: none"> 1. Incorrect connection or weak contact; 2. Communication line is damaged; 3. Communication port of the main board is damaged; 4. Fan speed control board is damaged. | <ol style="list-style-type: none"> 1. Check if the connection is correct (main board and terminal strip, terminal strip and display). 2. Connect the fan board directly to the main board to see if the fault is resolved. If the fault is resolved, the communication line is damaged. 3. Measure the change in voltage between ports A and B on the main board with a multimeter. If there is no change in value or the change remains around 0.1 V, the communication port is damaged. 4. If everything is in order, replace the fan speed control board. | <ol style="list-style-type: none"> 1 Reconnect. 2 Replace the communication line. 3 Replace the main board. 4 Replace the fan speed control board. |
| F12 | Communication error between DSP and PFC. | A | <ol style="list-style-type: none"> 1. The equipment is damaged | <ol style="list-style-type: none"> 1. Reset the power to check if the issue reoccurs. If it does, the control board is damaged. | <ol style="list-style-type: none"> 1. Replace the control board. |
| F11 | Communication error between DSP and communication board | A | <ol style="list-style-type: none"> 1. The equipment is damaged | <ol style="list-style-type: none"> 1. Reset the power to check if the issue reoccurs. If it does, the control board is damaged. | <ol style="list-style-type: none"> 1. Replace the control board. |

| | | | | | |
|------|---|---|---|---|--|
| F151 | Communication error between the compressor inverter board and the main control board. | A | <ol style="list-style-type: none"> 1. Incorrect connection or weak contact; 2. Communication line is damaged; 3. Communication port of the main board is damaged; 4. Compressor inverter board is damaged. | <ol style="list-style-type: none"> 1. Check if the connection is correct (main board and terminal strip, terminal strip and display). 2. Connect the compressor inverter board directly to the main board to check if the fault has been cleared. If the fault is cleared, the communication line is damaged. 3. Measure the voltage change between ports A and B on the main board using a multimeter. If there is no change in value or the change remains around 0.1 V, the communication port is damaged. 4. If all the above are okay, replace the compressor inverter board. | <ol style="list-style-type: none"> 1. Reconnect. 2. Replace the communication line. 3. Replace the main board. 4. Replace the compressor inverter board. |
| E08c | Communication error with the hydraulic module | A | <ol style="list-style-type: none"> 1. Check if the connection is correct or if there's a weak contact; 2. The communication line is damaged; 3. The communication port on the main board is damaged; 4. The printed circuit board of the hydraulic module is damaged. | <ol style="list-style-type: none"> 1. Check if the connection is correct (main board and terminal block, terminal block and display). 2. Connect the hydraulic module directly to the main board to check if the fault has been resolved. If the fault is cleared, the communication line is damaged. 3. Measure the voltage change between ports A and B on the main board with a multimeter. If there is no change in value or the change remains around 0.1 V, the communication port is damaged. 4. If all the above are okay, replace the printed circuit board of the hydraulic module. | <ol style="list-style-type: none"> 1. Reconnect. 2. Replace the communication line. 3. Replace the main board. 4. Replace the printed circuit board of the hydraulic module. |
| E084 | The display does not match the mainboard | A | <ol style="list-style-type: none"> 1. The display does not match the main control program. | <ol style="list-style-type: none"> 1. Check the software code and version number of the main control and wire control. | <ol style="list-style-type: none"> 1. Re-record the correct main control program. |

8.6. Sensors faults

Reset methods: A = automatic reset; M = manual reset; A/M = Limited automatic reset;

| Code | Name | Reset | Possible cause | Troubleshooting | Solutions |
|-------------------|---|-------|---|--|---|
| P01 | Fault in the water inlet temperature sensor | M | 1. Break in the circuit or short circuit of the inlet water temperature sensor. 2. Damage to the inlet water temperature sensor. | 1. Check the connection and resistance of the inlet water temperature sensor. 2. The inlet water temperature sensor is damaged. | 1. Reconnect the sensor. 2. Replace the inlet water temperature sensor. |
| P02 | Fault in the water outlet temperature sensor | M | 1. Break in the circuit or short circuit of the outlet water temperature sensor. 2. Damage to the outlet water temperature sensor. | 1. Check the connection and resistance of the outlet water temperature sensor. 2. The outlet water temperature sensor is damaged. | 1. Reconnect the sensor. 2. Replace the outlet water temperature sensor. |
| P04 | Ambient Temperature Sensor Error | M | 1. Break in the circuit or short circuit of the ambient temperature sensor. 2. Damage to the ambient temperature sensor. | 1. Reconnect the sensor. 2. Replace the outlet water temperature sensor. | 1. Reconnect the sensor. 2. Replace the ambient temperature sensor. |
| P17 | Error in the compressor suction temperature sensor | M | 1. Open or short circuit in the suction temperature sensor circuit. 2. Malfunction of the suction temperature sensor. | 1. Check the connection and resistance of the suction temperature sensor. 2. The suction temperature sensor is damaged. | 1. Reconnect the sensor. 2. Replace the ambient temperature sensor. |
| P081, P181 / P182 | Error in the discharge temperature sensor / over-temperature in discharge | M | 1. Open circuit or short circuit in the exhaust temperature sensor circuit. 2. Malfunction of the exhaust temperature sensor. | 1) Check the connection and resistance of the exhaust temperature sensor. 2) The exhaust temperature sensor is damaged. | 1) Reconnect the sensor. 2) Replace the exhaust temperature sensor. |
| P09, P191 | Error of the fluid temperature sensor. | M | 1. Open circuit or short circuit in the fluid temperature sensor circuit. 2. Malfunction of the fluid temperature sensor. | 1. Check the connection and resistance of the fluid temperature sensor. 2. The fluid temperature sensor is damaged. | 1. Reconnect the sensor. 2. Replace the fluid temperature sensor. |

| | | | | | |
|-------------|--|---|---|---|---|
| PP11 | Pressure sensor error. | M | 1. Open circuit or short circuit in the fluid temperature sensor circuit. 2. Malfunction of the fluid temperature sensor. | 1. Check the connection and resistance of the pressure sensor. 2. The pressure sensor is damaged. | 1. Reconnect the sensor. 2. Replace the pressure sensor. |
| P152 / P153 | Fault of the heat exchanger/diverter temperature sensor. | M | 1. Open circuit or short circuit in the pressure sensor circuit. 2. Malfunction of the pressure sensor. | 1. Check the connection and resistance of the temperature sensor at the coil outlet. 2. Damaged temperature sensor at the coil outlet. | 1. Reconnect the sensor. 2. Replace the temperature sensor at the coil outlet. |
| PP12 | Error of the high-pressure sensor. | M | 1. Open circuit or short circuit of the temperature sensor at the coil outlet. 2. Damage to the temperature sensor at the coil outlet. | 1. Check the connection of the pressure sensor. 2. The high-pressure sensor is damaged. | 1. Reconnect the sensor. 2. Replace the high-pressure sensor. |
| P03a | Fault of the buffer tank temperature sensor. | M | 1. Break in the circuit or short circuit of the temperature sensor in the buffer tank. 2. Damage to the temperature sensor in the buffer tank. | 1. Check the connection and resistance of the temperature sensor in the buffer tank. 2. The temperature sensor in the buffer is damaged. | 1. Reconnect the sensor. 2. Replace the temperature sensor in the buffer tank. |
| P03 | Failure of the hot water (DHW) tank temperature sensor. | M | 1. Open circuit or short circuit of the water tank temperature sensor. 2. Damage to the water tank temperature sensor. | 1. Open circuit or short circuit of the water tank temperature sensor. 2. Damage to the water tank temperature sensor. | 1. Reconnect the sensor. 2. Replace the water tank temperature sensor. |
| P42 | Error in room temperature sensor | M | 1. Open circuit or short circuit in the room temperature sensor. 2. Damage to the room temperature sensor. | 1. Check the connection and resistance of the room temperature sensor. 2. The room temperature sensor is damaged. | 1. Reconnect the sensor 2. Replace the room temperature sensor |

| | | | | | |
|------|---|---|---|--|---|
| P013 | Fault of the temperature sensor for the water returning to the heating system | M | <ol style="list-style-type: none"> 1. Open circuit or short circuit of the temperature sensor for the water returning to the heating system. 2. Damage to the temperature sensor for the water returning to the heating system. | <ol style="list-style-type: none"> 1. Check the connection and resistance of the temperature sensor for the water returning to the heating system. 2. The temperature sensor for the water returning to the heating system is damaged. | <ol style="list-style-type: none"> 1. Reconnect the sensor 2. Replace the temperature sensor for the water returning to the heating system |
| P023 | Failure of the temperature sensor in the heating outlet water. | M | <ol style="list-style-type: none"> 1. Break in the circuit or short circuit of the temperature sensor in the water outlet of the heating. 2. Damage to the temperature sensor at the outlet of the heating. | <ol style="list-style-type: none"> 1. Check the connection and resistance of the water temperature sensor at the heating outlet. 2. The temperature sensor in the water outlet of the heating is damaged. | <ol style="list-style-type: none"> 1. Reconnect the sensor. 2. Replace the water temperature sensor at the heating outlet. |
| P02a | Failure of the water temperature sensor at the outlet from the water mixer. | M | <ol style="list-style-type: none"> 1. Break in the circuit or short circuit of the water temperature sensor at the outlet from the water mixer. 2. Damage to the water temperature sensor at the outlet from the water mixer. | <ol style="list-style-type: none"> 1. Check the connection and resistance of the water temperature sensor at the outlet from the water mixer. 2. The water temperature sensor at the outlet from the water mixer is damaged. | <ol style="list-style-type: none"> 1. Reconnect the sensor. 2. Replace the water temperature sensor at the outlet from the water mixer. |
| P018 | Fault of the DHW return sensor. | M | <ol style="list-style-type: none"> 1. Open circuit or short circuit of the return temperature sensor for hot water. 2. Damage to the return temperature sensor for hot water. | <ol style="list-style-type: none"> 1. Check the connection and resistance of the return temperature sensor for hot water. 2. The return temperature sensor for hot water is damaged. | <ol style="list-style-type: none"> 1. Reconnect the sensor. 2. Replace the return temperature sensor for hot water. |
| P028 | Failure of the domestic hot water (DHW) supply sensor. | M | <ol style="list-style-type: none"> 1. Open circuit or short circuit of the sensor for the outlet temperature of hot water. 2. Damage to the sensor for the outlet temperature of hot water. | <ol style="list-style-type: none"> 1) Check the connection and resistance of the sensor for the temperature of hot water at the outlet. 2) The sensor for the temperature of hot water at the outlet is damaged. | <ol style="list-style-type: none"> 1. Reconnect the sensor. 2. Replace the sensor for the temperature of hot water at the outlet |
| P02a | Error of the water temperature sensor at the outlet of mixing. | M | <ol style="list-style-type: none"> 1. Open or short circuit in the circuit of the water temperature sensor at the outlet of mixing. 2. Damage to the water temperature sensor at the outlet of mixing. | <ol style="list-style-type: none"> 1) Check the connection and resistance of the water temperature sensor at the outlet of mixing. 2) The water temperature sensor at the outlet of mixing is damaged. | <ol style="list-style-type: none"> 1. Reconnect the sensor. 2. Replace the water temperature sensor at the outlet of mixing; it is damaged. |

8.7. System faults

Reset methods: A = automatic reset; M = manual reset; A/M = Limited automatic reset;

| Code | Name | Reset | Possible cause | Troubleshooting | Solutions |
|------|-------------------------|-------|---|--|--|
| E01 | Overpressure protection | A | <ol style="list-style-type: none"> 1. High-pressure switch is damaged or improperly connected; 2. Plate heat exchanger is dirty/clogged; (Heating) 3. Air heat exchanger is dirty/blocked, insufficient airflow (Cooling) 4. Improper operation of the expansion valve 5. Incorrect water flow; 6. Outlet water temperature is too high; 7. Excessive amount of refrigerant. | <ol style="list-style-type: none"> 1. Use a multimeter to check if the high-pressure switch is closed after stopping for 3 minutes. If it is disconnected, check the connection of the high-pressure switch. If it remains disconnected after checking the connection, it can be determined that the high-pressure switch is damaged. 2. Check for scale buildup on the inlet and outlet of the plate heat exchanger housing and observe the deposition of scale on the internal wall. If the amount of scale is large, it can be concluded that scale is causing the high-pressure protection. 3. Check if the airflow is correct and free from foreign bodies. 4. Check the opening of the electronic expansion valve, manually increase or decrease the opening of the electronic expansion valve, and observe if there are changes in high and low pressures, suction temperature, and exhaust temperature. If not, it means the electronic expansion valve is damaged or blocked, the coil is faulty, or the opening is small. After eliminating the causes 1, 2, 3, 5, and 6, check for blockage before throttling. 5. Check the set temperature, especially when the set temperature is close to the critical operating temperature. Verify if the detected water temperature value at the outlet before the fault is lower than the actual temperature by more than 2°C. 6. Connect a pressure gauge, start heating after fixing the fault, then read the high pressure and temperature of the refrigerant before the fault, convert the high pressure to the condensing temperature, and calculate the sub-cooling = condensing temperature - outlet water temperature. If the sub-cooling is > 10°C, it can be concluded that the refrigerant is overloaded. If there are no abnormalities, contact an authorized service center. | <ol style="list-style-type: none"> 1. Reconnect the connecting wire or replace the high-pressure switch. 2. Consult specialists for the cleaning of the plate heat exchanger. 3. Clean the finned heat exchanger. 4. Replace the expansion valve or the coil and filter. 5. Fill with refrigerant according to the specified filling amount on the nameplate, paying attention to evacuating and drying the refrigeration system. |

| | | | | | |
|-----|--------------------------|---|--|---|---|
| E02 | Underpressure protection | A | <ol style="list-style-type: none"> 1. Refrigerant leakage in the system. 2. Incorrect connection or damage to the low-pressure switch. 3. Ineffective defrosting. 4. Dirty air finned heat exchanger, insufficient airflow. 5. Improper operation of the expansion valve. 6. Blocked refrigeration system. | <ol style="list-style-type: none"> 1. Connect a pressure gauge to the low-pressure side and observe changes in refrigerant pressure. If it drops below 0 bar, it indicates refrigerant leakage. If it is above 0 bar, proceed to the next step. 2. Use a leak detector to locate refrigerant leaks. If leak points are detected, welding repairs are required. If no leak points are found, check if the compressor current and temperature difference between the inlet and outlet water are low after startup. If yes, run the machine to heat up after re-evacuation and recharge. If there are no abnormalities after recharging with refrigerant, it means the device is lacking refrigerant. If low-pressure protection still occurs, move on to the next step. 3. Connect a pressure gauge and observe if the gauge pointer reaches the switch-off range of the low-pressure switch before the machine fails. If not, check if the connection of the low-pressure switch is loose or if the switch is damaged. If yes, move on to the next step. 4. Check if the air finned heat exchanger is heavily frosted. If so, check whether the machine will still activate low-pressure protection after manual defrosting. If it operates normally, it indicates poor defrosting. If low-pressure protection continues, proceed to the next step. 5. Check if the airflow through the heat exchanger is correct. If yes, move on to the next step. 6. Check if the electronic expansion valve coil and body are securely attached, if the connection between the coil and the mainboard is not loose, etc. After checking, run the heating. If low-pressure protection still operates, move on to the next step. | <ol style="list-style-type: none"> 1. Perform welding repairs, maintain pressure, purge air, and replenish refrigerant according to the quantity specified on the nameplate. 2. Improve the connection of the pressure switch or replace the pressure switch. 3. Perform manual defrosting, then adjust the defrosting setting parameters, shorten the heating cycle, extend the defrosting time, increase the set water temperature, etc. 4. Clean the heat exchanger to remove dirt and impurities. 5. Replace or tighten the electronic expansion valve coil, tap, or replace the body of the electronic expansion valve. 6. Check or replace the filter, clean the filter of contaminants before throttling, or replace the filter. |
|-----|--------------------------|---|--|---|---|

| | | | | | |
|-----|---|-----|--|--|--|
| | | | | <p>7. Gently tap the electronic expansion valve body a few times and restart the device to heat up. If heating is normal, the electronic expansion valve is blocked. If low-pressure protection still operates, proceed to the next step.</p> <p>8. Remove refrigerant from the system and take out the filter for inspection. If there is a blockage, it is the cause of low-pressure protection. If the filter is normal, contact an authorized service center.</p> | |
| E03 | Water Flow Switch Protection | A | <p>1. Water pump failure;</p> <p>2. Water installation is not completely purged of air;</p> <p>3. Excessive resistance in the water installation;</p> <p>4. Valves in the water installation are not fully open;</p> <p>5. Circulating water filter is dirty and blocked;</p> <p>6. Water flow sensor is incorrectly connected or damaged.</p> | <p>1. Check if the water pump is working and observe if the water pump control light indicates a malfunction;</p> <p>2. Bleed the upper part of the water system;</p> <p>3. Check the length of the circulating water system, the number of valves, elbows, tees, etc., and calculate the water resistance;</p> <p>4. Check if all the valves in the water installation that should be open are indeed open;</p> <p>5. Check if the circulating water filter is not dirty and clogged with too many impurities;</p> <p>6. Verify that the water flow sensor connection is correct and check if the water flow sensor contact is functional (closed and open) using a multimeter. If the issues persist after performing the above troubleshooting steps, contact an authorized service center.</p> | <p>1. Resolve the issue with the pump or replace the pump;</p> <p>2. Open the air release valves in the system and completely bleed the system;</p> <p>3. Calculate and check the hydraulic resistances in the water system. If the water resistance is too high, add an auxiliary pump;</p> <p>4. Check all the valves in the water circuit, and all valves that should be open must be open;</p> <p>5. Clean the circulating water filter from impurities;</p> <p>6. Check the connection and tighten it again. If the water flow sensor is not responding correctly, replace the water flow switch.</p> |
| E05 | Antifreeze protection for the water circuit | A/M | <p>1. Insufficient water flow;</p> <p>2. The water temperature at the outlet is too low;</p> | <p>1. Check if the water flow is low. If it's low, refer to the troubleshooting methods 1-5 for the water flow sensor. If the water flow is normal, proceed to the next step;</p> <p>2. Check if the water temperature at the outlet before the protection is too low. If so, increase the set water temperature value. If not, proceed to the next step;</p> <p>3. If the issues persist after performing the above troubleshooting steps, contact an authorized service center.</p> | <p>1. Familiarize yourself with solutions 1-5 for the water flow sensor.</p> <p>2. Increase the set water temperature.</p> |

| | | | | | |
|------|--|-----|---|---|---|
| E06 | Protection against overheating of the inlet and outlet water | A/M | 1. Insufficient water flow; | <ol style="list-style-type: none"> 1. Check if the water flow is low. If it is low, refer to the troubleshooting methods 1-5 for the water flow sensor. If the water flow is normal, proceed to the next step. 2. Check if the ambient temperature is higher than 30°C. 3. If problems persist after performing the above steps, contact an authorized service center. | <ol style="list-style-type: none"> 1. Familiarize yourself with the troubleshooting methods 1-5 for the water flow sensor. 2. Reduce the set value of parameter setting position F06 on the display. |
| TP | Protection against shutdown in low ambient temperature | A/M | <ol style="list-style-type: none"> 1. The ambient temperature is too low. 2. Check the installation location. | <ol style="list-style-type: none"> 1. Check if the ambient temperature is not too low. 2. Verify if the value measured by the temperature sensor is not much lower than the actual ambient temperature. | <ol style="list-style-type: none"> 1. If the device is outside the working range and cannot be started, it is recommended not to use it. 2. Replace the ambient temperature sensor or change the installation location of the temperature sensor. |
| P082 | Protection against air overheating in exhaust. | A/M | <ol style="list-style-type: none"> 1. Lack of refrigerant in the system; 2. Dirty heat exchanger; 3. Frost/ice-covered heat exchanger; 4. Air heat exchanger is dirty, and airflow is insufficient; 5. Malfunctioning expansion valve; 6. Outlet water temperature is too high; 7. System lockout. | <ol style="list-style-type: none"> 1. Connect the pressure gauge and observe the refrigerant pressure. If it exceeds 0 bar, it indicates a refrigerant leak. If it is greater than 0 bar, proceed to the next step. 2. Use a leak detector to find the leak. If a leak is detected, it requires welding repair. If no leaks are found, check if the compressor current and the temperature difference between the inlet and outlet water are low after starting. If the error persists after refilling the refrigerant, proceed to the next step. 3. Check for scale deposits on the inlet and outlet of the plate heat exchanger and on the internal wall. If there is a significant amount of scale, the device can only be operated after descaling. If the malfunction persists after cleaning the exchanger, proceed to the next step. 4. Check if the air heat exchanger is heavily frosted. If so, check if the machine is still protected under low pressure after manually defrosting. If it operates normally, the issue is due to improper defrosting. If the low pressure persists, move on to the next step. 5. Check if the airflow is correct | <ol style="list-style-type: none"> 1. Replenish the refrigerant. 2. Seek professional assistance for descaling. 3. Manual defrosting and proper adjustment of defrosting parameters. 4. Clean the air heat exchanger. 5. Replace the body or coil of the electronic expansion valve. 6. Replace the sensor or use heat-protective and conductive agents, or relocate the sensor to an appropriate position, or lower the water temperature setting. 7. Replace the filter or clean a dirty and blocked filter. |

| | | | | | |
|------|--|-----|---|--|--|
| | | | | <p>6. Check if the coil and electronic expansion valve body are securely attached, and the connection between the coil and the main board is not loose, etc. After checking, start the heating, and if the low-pressure protection still works, proceed to the next step.</p> <p>7. Tap the electronic expansion valve body gently a few times and restart the machine to warm up. If the operation is normal, the electronic expansion valve is stuck. If the low-pressure protection still works, move on to the next step.</p> <p>8. Check the deviation between the detected water temperature value and the actual value. If it is significantly lower, the sensor needs replacement.</p> <p>9. Remove the refrigerant from the system and take out the filter for inspection. Replace it if it is blocked by dirt or clean it and run it for a trial. If it operates normally, the problem is resolved. If the filter is normal, contact an authorized service center.</p> | |
| E04 | Protection of the electric heating element against over-heating. | A/M | <ol style="list-style-type: none"> 1. The electric heater operates without load. 2. Insufficient water flow. 3. Incorrectly connected or damaged overload protection switch for electric heating. 4. Incorrect connection of the terminal strip jumper for overload protection of electric heating. | <ol style="list-style-type: none"> 1. Check if there is water in the water installation, and if so, proceed to the next step. 2. Verify if the water flow is not too low. If the water flow is low, check the reasons for the low water flow. Refer to the troubleshooting methods 1 ~ 5 in the water flow sensor section. If the water flow is normal, proceed to the next step. 3. Check if the overload protection switch is closed in the off state. If it is open, check if the connection is false. If there is no irregularity in the connection, the overload switch is damaged. If it is closed, contact an authorized service center. | <ol style="list-style-type: none"> 1. Fill the water system, bleed the air. 2. Familiarize yourself with methods 1 ~ 5 for the water flow sensor. 3. Attach the wire connecting the overload protection switch, replace the overload protection switch, or replace the electric heating element assembly. |
| E065 | Protection against over-heating of the outlet water. | A | <ol style="list-style-type: none"> 1. Insufficient water flow. 2. Improper selection. 3. The terminal is not open. | Refer to troubleshooting methods 1 ~ 5 for the water flow sensor. | Refer to troubleshooting methods 1 ~ 5 for the water flow sensor. |
| E071 | Protection against excessively low water temperature at the outlet | A | <ol style="list-style-type: none"> 1. Insufficient water flow. 2. Improper selection. 3. The terminal is not open. | Refer to troubleshooting methods 1 ~ 5 for the water flow sensor. | Refer to troubleshooting methods 1 ~ 5 for the water flow sensor. |

| | | | | | |
|---|---|---|--|--|---|
| / | Severe frost formation on the heat exchanger. | / | <ol style="list-style-type: none"> 1. Insufficient installation space. 2. Water temperature is too low. 3. Insufficient amount of refrigerant. 4. Water flow is insufficient for normal defrosting. | <ol style="list-style-type: none"> 1. Check if the airflow is correct and if the space meets the requirements of the instructions. 2. Check if the return water temperature is lower than the parameter D11. 3. Check if there is a sufficient amount of refrigerant in the device. 4. Check if the water flow in the device is lower than the parameter D22. | <ol style="list-style-type: none"> 1. Remove contaminants from the heat exchanger. 2. Adjust the set water temperature to meet D22 and the set minimum water temperature at the inlet for defrosting. 3. Replenish the refrigerant. 4. Add an auxiliary pump. |
| / | The water temperature cannot reach the set value. | / | <ol style="list-style-type: none"> 1. The selected heat pump is too small. 2. The ambient temperature is too low. 3. Insufficient amount of refrigerant. 4. Excessively high water temperature, compressor frequency limited. 5. Insufficient water flow, compressor frequency limited. | <ol style="list-style-type: none"> 1. Check the selected model. 2. Verify if the ambient temperature is not too low and if it is lower than the external heating project environment. 3. Check if the refrigerant level is sufficient. 4. Check if the set water temperature is not too high. If it exceeds 55°C, there will be a limitation on the compressor current frequency and a reduction in frequency. 5. Check if the water flow is less than 50% of the nominal flow. | <ol style="list-style-type: none"> 1. If the selected model is too small, replace the machine. 2. Add additional electric heating. 3. Replenish the refrigerant. 4. Lower the set water temperature appropriately. 5. Add an auxiliary pump. |

8.8. Multiple-zone control malfunctions.

Reset methods: A = automatic reset; M = manual reset; A/M = Limited automatic reset;

| Code | Name | Reset | Possible cause | Troubleshooting | Solutions |
|------------|--|-------|---|--|--|
| E122 | Incorrect regulation of the mixing valve. | M | <ol style="list-style-type: none"> 1. The mixing valve is incorrectly connected. 2. The mixing valve is damaged. | <ol style="list-style-type: none"> 1. Check the connection of the Mixing Valve according to the circuit diagram, ensuring that the connection is correct and the contact is not weak. 2. Check the rotating parts of the mixing valve to see if they are blocked or not. | <ol style="list-style-type: none"> 1. Connect and disconnect the terminals. 2. Replace the mixing valve. |
| P105; P106 | Error in the temperature sensor of zone 1. | | <ol style="list-style-type: none"> 1. Circuit break or short circuit in the room temperature sensor. 2. Damage to the room temperature sensor. | <ol style="list-style-type: none"> 1. Check the connection and resistance of the temperature sensor. 2. The temperature sensor is damaged. | <ol style="list-style-type: none"> 1. Reconnect the sensor. 2. Replace the temperature sensor. |
| P107 | Error in the temperature sensor of zone 2. | | <ol style="list-style-type: none"> 1. Break or short circuit in the circuit of the mixer temperature sensor. 2. Damage to the mixer temperature sensor. | <ol style="list-style-type: none"> 1. Check the connection and resistance of the temperature sensor. 2. The temperature sensor is damaged. | <ol style="list-style-type: none"> 1. Reconnect the sensor. 2. Replace the temperature sensor. |

9.9. Components List

9.1. Assembly Drawing

Model KHY-12PY3 (example)

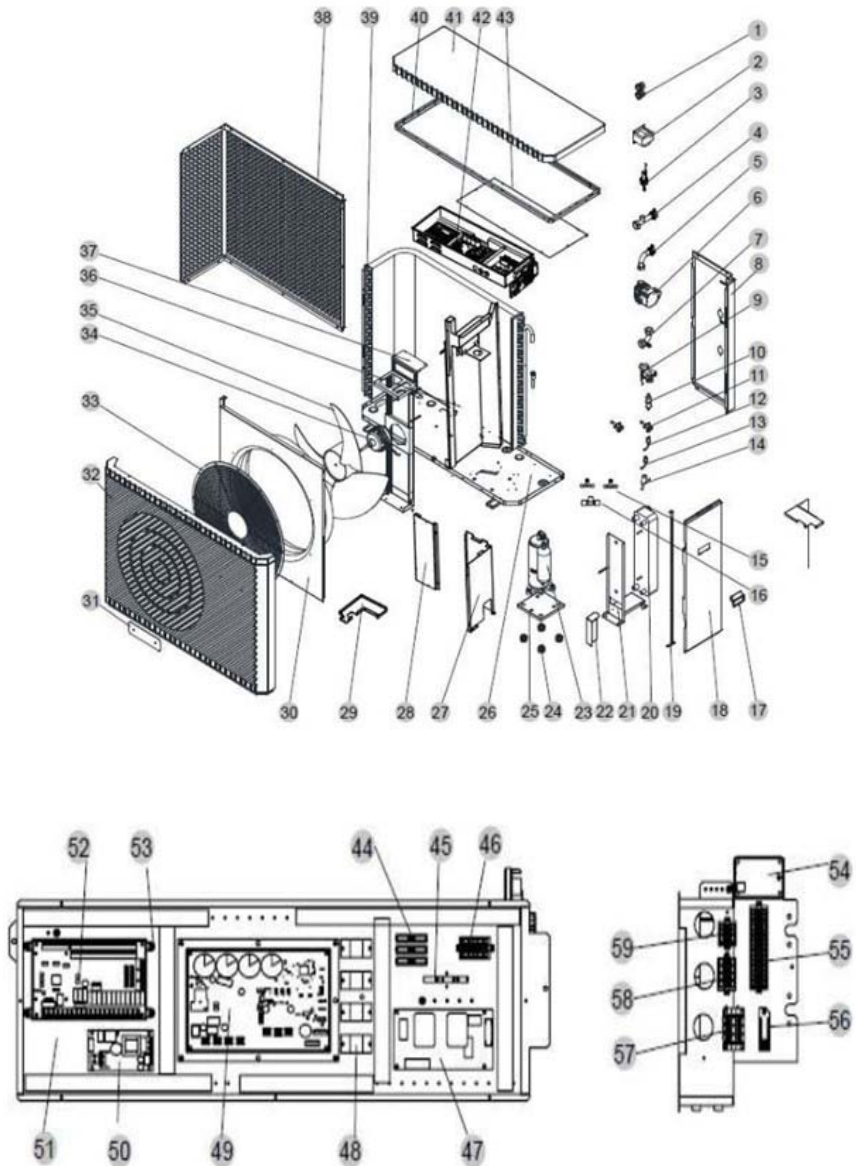

Component Descriptions:

| Nr | Name | Quantity |
|----|----------------------------------|----------|
| 1 | Waterproof Cable Glands (Black) | 2 |
| 2 | Reactor | 1 |
| 3 | Water Flow Sensor | 1 |
| 4 | Outlet Pipe Connectors | 1 |
| 5 | Inlet Pipe Connectors | 1 |
| 6 | Water pump | 1 |
| 7 | Water Pump Connector | 1 |
| 8 | Rear Side Cover Plate. | 1 |
| 9 | Four-way Valve and Accessories | 1 |
| 10 | Filter | 2 |
| 11 | Shut-off Valve | 2 |
| 12 | Pressure Switch | 1 |
| 13 | Pressure Switch | 1 |
| 14 | Electronic Expansion Valve | 1 |
| 15 | Tee | 2 |
| 16 | Tee | 1 |
| 17 | Handle | 1 |
| 18 | Right Side Cover Plate | 1 |
| 19 | Panel Bracket | 1 |
| 20 | Plate Heat Exchanger | 1 |
| 21 | Plate Heat Exchanger Bracket | 1 |
| 22 | Water Pump Bracket | 1 |
| 23 | Compressor and Accessories (P95) | 1 |
| 24 | Compressor Vibration Damper | 4 |
| 25 | Compressor Mounting Base | 1 |
| 26 | Main Board | 1 |
| 27 | Cover 1 for Compressor | 1 |
| 28 | Cover 2 for Compressor | 4 |
| 29 | Cover for Compressor | 1 |
| 30 | Fan Air Channel | 1 |

| Nr | Name | Quantity |
|----|---------------------------------------|----------|
| 31 | Marking | 1 |
| 32 | Front Cover | 1 |
| 33 | Fan Grille | 1 |
| 34 | DC Fan Motor | 1 |
| 35 | Axial Fan Blade | 1 |
| 36 | Internal Plate | 1 |
| 37 | Motor Bracket Assembly | 1 |
| 38 | Rear Cover | 1 |
| 39 | Finned Heat Exchanger | 1 |
| 40 | Top Beam | 1 |
| 41 | Top Cover | 1 |
| 42 | Electric Control Element | 1 |
| 43 | Electric Box Cover | 1 |
| 44 | 2-position Terminal Block | 1 |
| 45 | Fuse Terminal | 1 |
| 46 | Terminal Strip | 1 |
| 47 | Variable Frequency Drive Filter Board | 1 |
| 48 | Relay | 1 |
| 49 | Frequency Inverter Module | 1 |
| 50 | Power Supply Module | 1 |
| 51 | Electrical Box | 1 |
| 52 | PC4003 | 1 |
| 53 | Plastic Base | 1 |
| 54 | DTU1007 | 1 |

Products are subject to continuous improvement, therefore Klima-Therm Sp. z o.o. reserves the right to change documents and technical parameters at any time, without prior notice.

Version: January 2023

Thank you for choosing our product.
For more information, please visit the website: kaisai.com

www.kaisai.com

**WE
CARE
ABOUT
AIR**